

FLEXIBLE THERMAL POWER PLANTS: BRIDGE TO A DECARBONIZED ENERGY SYSTEM

Practical solutions for System Flexibility : Case Studies

Anjan Kumar Sinha

24 November, 2022

AGENDA

01

Market Drivers of Flexibilization of Coal Units

02

Impact of Market Drivers on Power Plant

03

Relative Economics of Grid Integrating Options

04

Costs Associated with Flexibilization (CAPEX & OPEX)

05

Redesigning Tariff Structure/ Interventions

06

Decommissioning Costs/ Benefits with Repurposing

07

Understanding the Damages – Implications

08

Roadmap for Flexible Operation of Fleet

09

Summary

10

Questions & Answers

COAL HAS BEEN THE MAINSTAY OF THE POWER GENERATION IN INDIA

GENERATING CAPACITY SOURCE

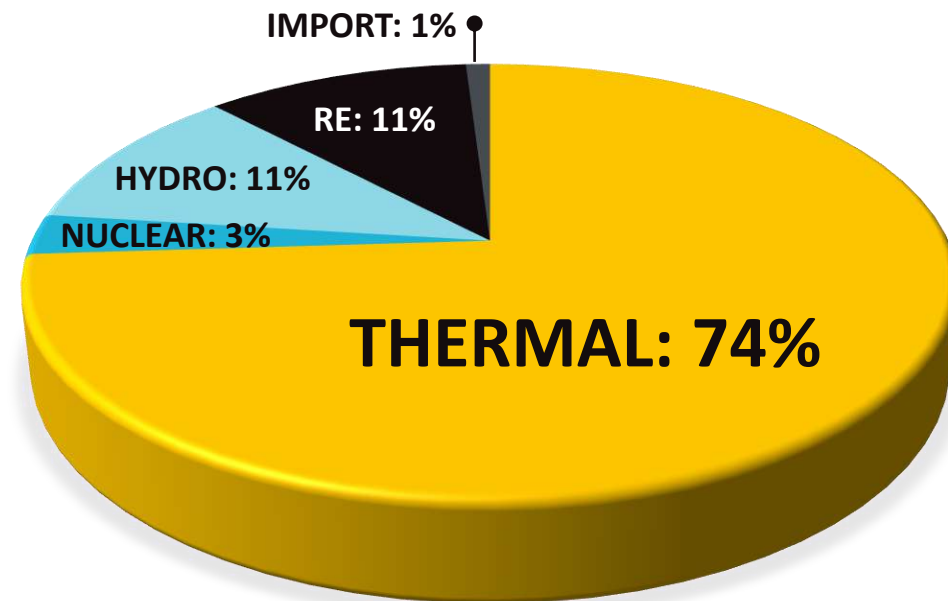
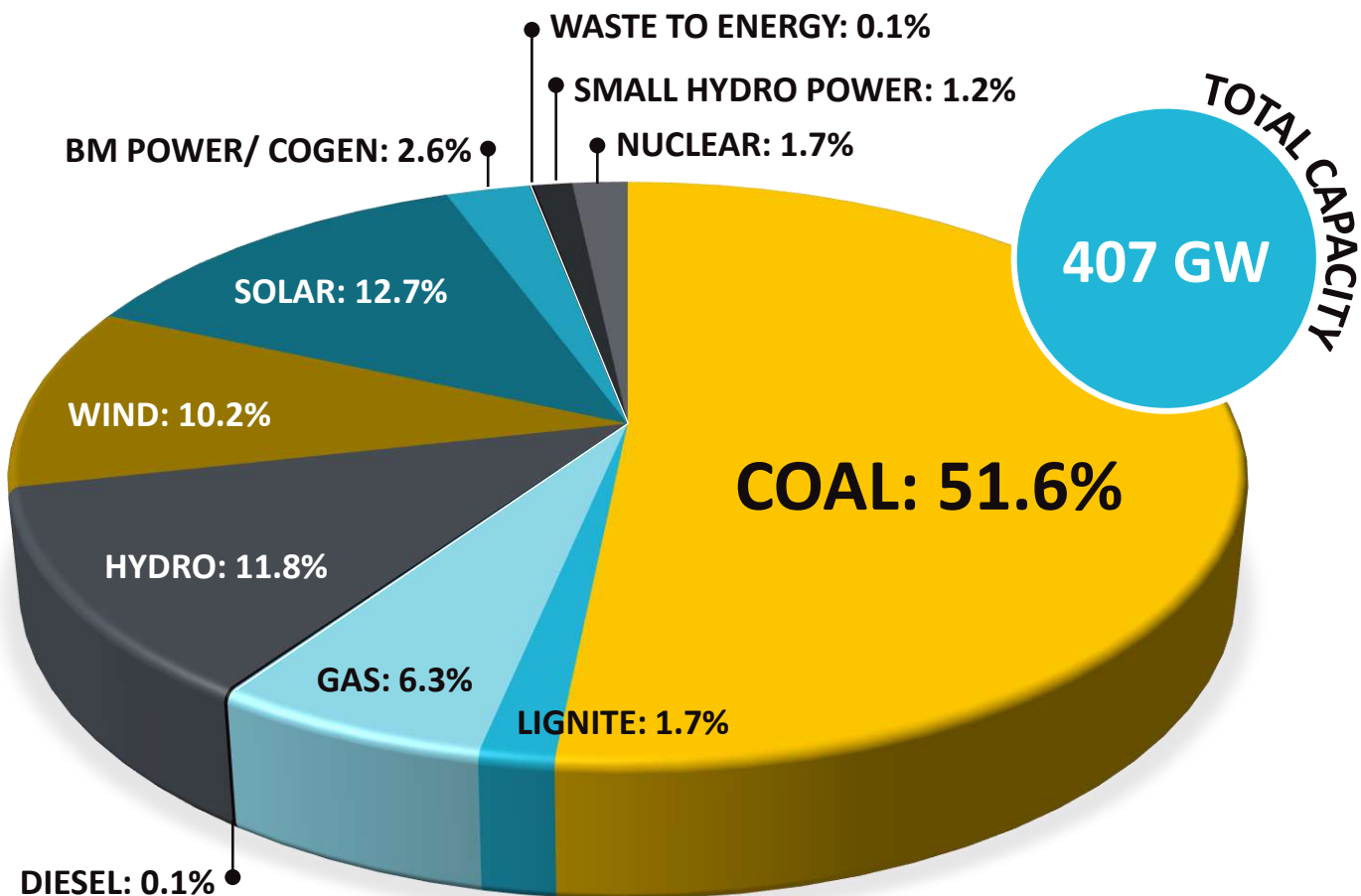

SOURCEWISE GENERATION

THE INDIAN TRANSITION

- India's pledge to increase the share of non-fossil fuels-based electricity to 40 percent by 2030
- 500 GW RE by 2030
- Coal in India is increasingly needed to flexible and play a greener role
- Inadequacy of other balancing resources
- Coal is the mainstay of power generation in India
- Fuel economics-Non-Pit head stations will have costlier fuel
- Tightening environmental legislation
- Transition to electricity market mechanisms – markets will force to operate more efficiently, even during flexible operation

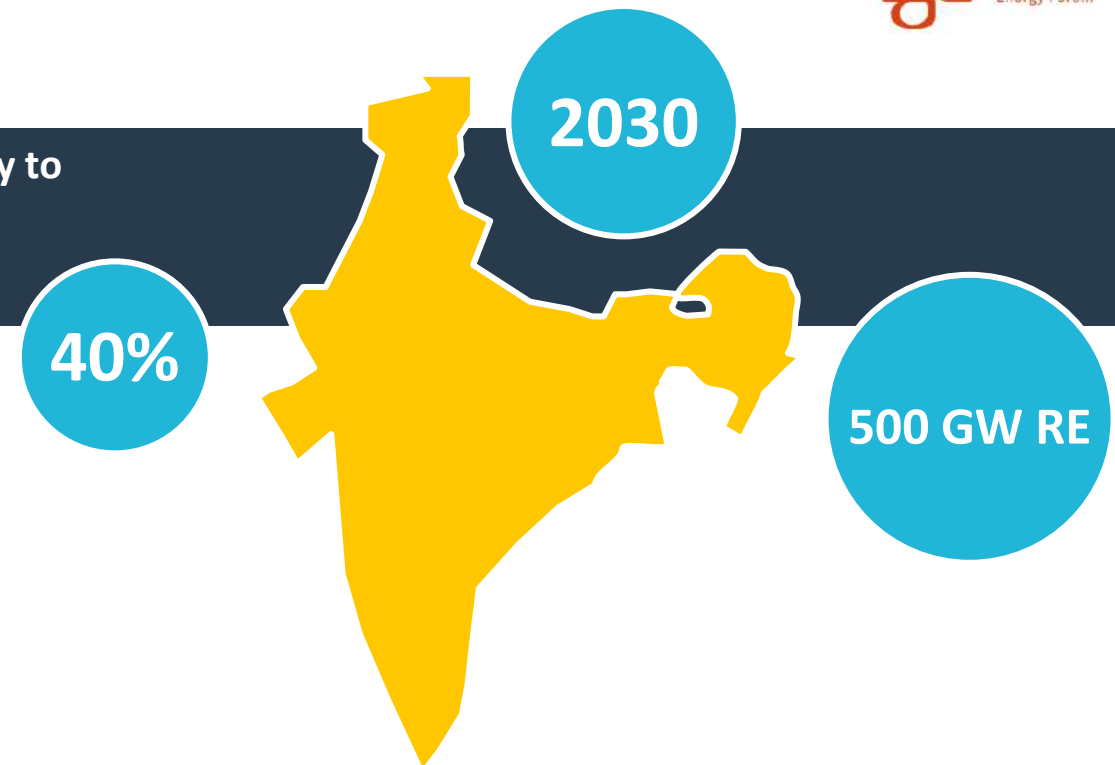

PLF% TREND NATIONAL CENTRAL STATE PRIVATE

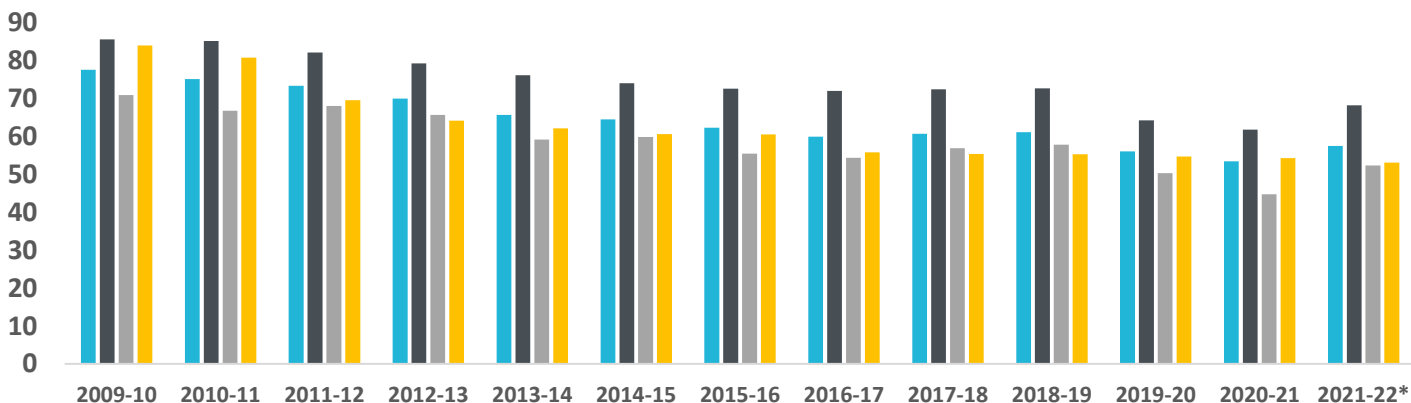

Total Gen. (incl RE)% of growth

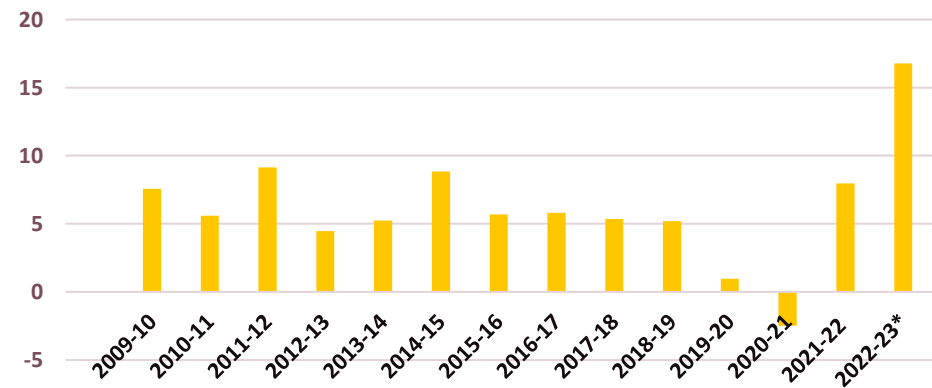

THE INDIAN ELECTRICITY MARKET

VOLUME OF VARIOUS KINDS OF ELECTRICITY TRANSACTIONS IN TOTAL ELECTRICITY GENERATION

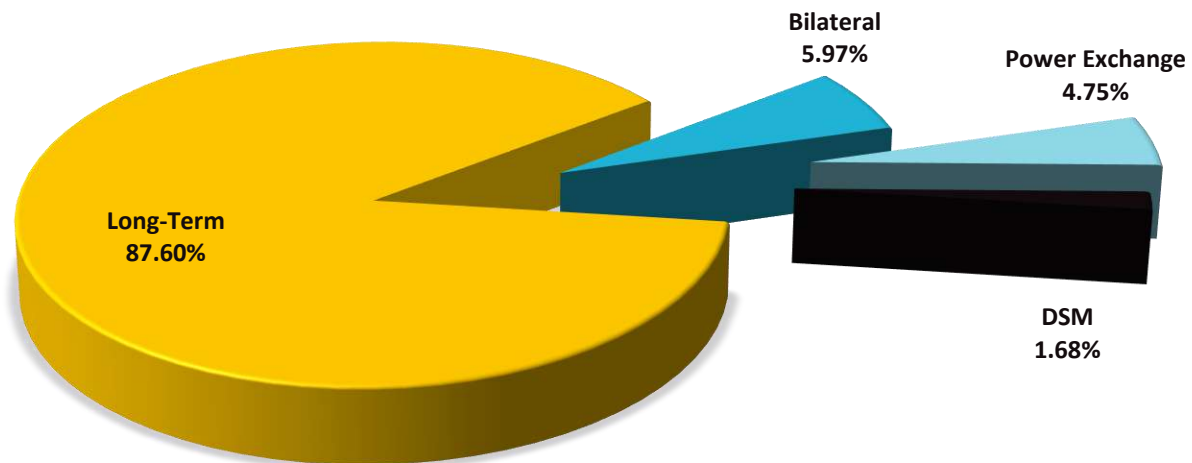

VOLUME TRANSACTED IN DIFFERENT MARKET SEGMENTS

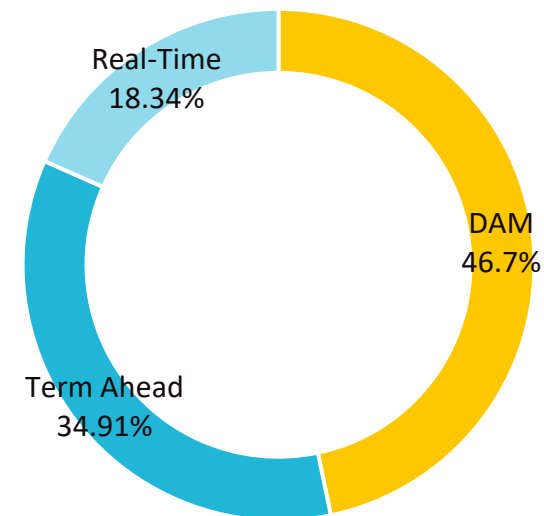

APRIL 2022

- Largely Long-term Physical Contracts, Supplies on Day-Ahead Basis & PPAs on Two-Part Tariffs (Capacity Charges & Variable Charges)
- DSM (Deviation Settlement Mechanism) To Address Intra Day Energy Requirements As Well As System Imbalances
- AGC in ISGS Stations
- SCED
- Flexibility in Generation & Scheduling
- Day-Ahead Market & Real Time Market
- Compensation Mechanism for Part Load Operation

WHAT ARE THE MODES OF FLEXIBLE OPERATION?

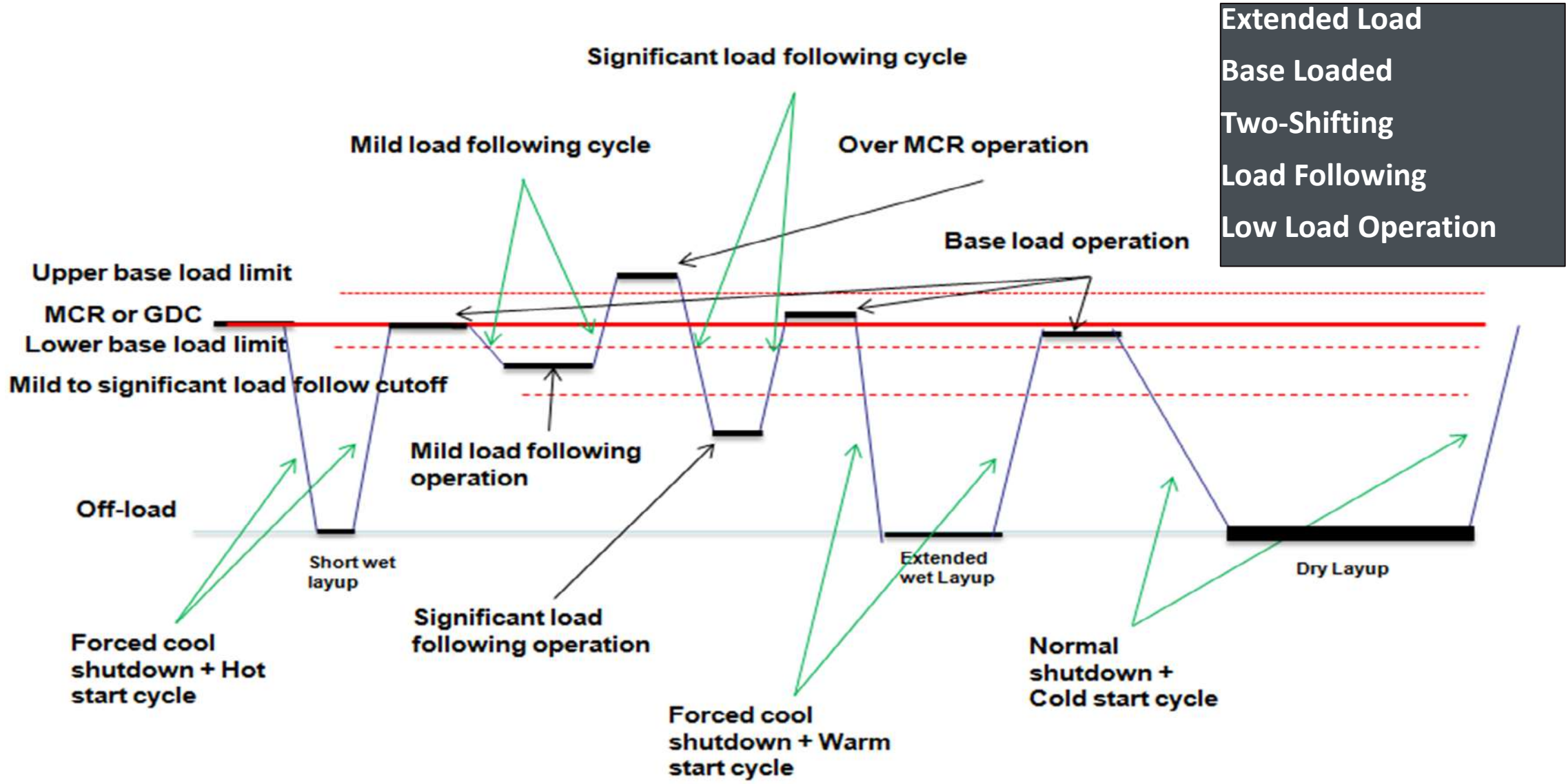

REAL EXAMPLE

SCHEDULING OF A UNIT & THE EFFECT

If we consider a significant load following of ramp size >15%, then we have **AT LEAST 7 SIGNIFICANT LOAD FOLLOWINGS**

Each of this event costing >2lakhs INR for the generator, which the **GENERATOR HAS NO WAY TO RECOVER** from the present regulatory mechanism

are the **SYSTEM OPERATORS, UTILITIES & POLICY MAKERS ALIGNED?**

is this an **ECONOMIC DISPATCH?**

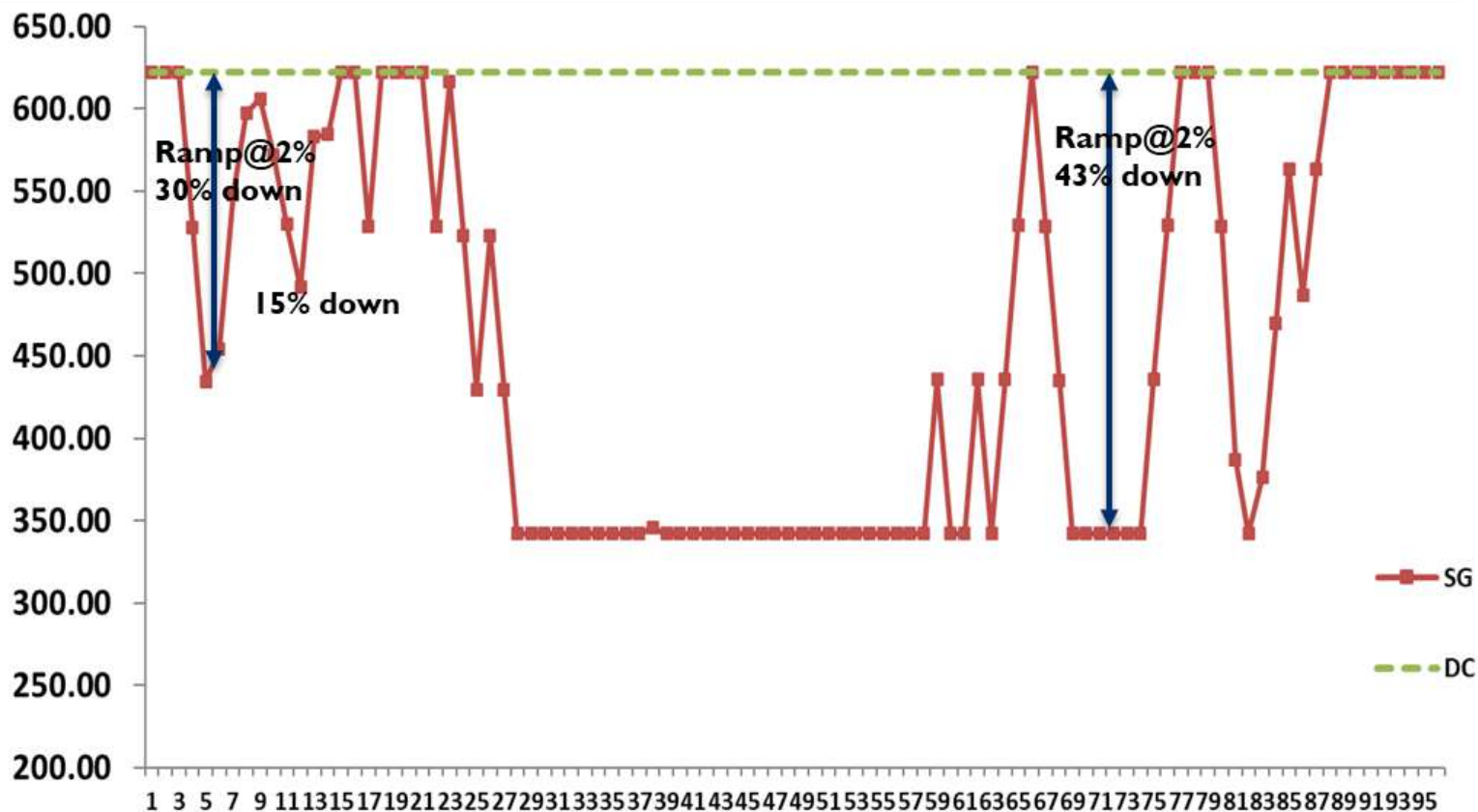

RISKS

- Safety Issues
- O&M Cost – Under Recovery
- Cost of Failures
- Efficiency Loss
- Increased Emissions

OPPORTUNITIES

- Primary Response
- Secondary Response/ AGC
- Ancillary Service Markets
- RTM

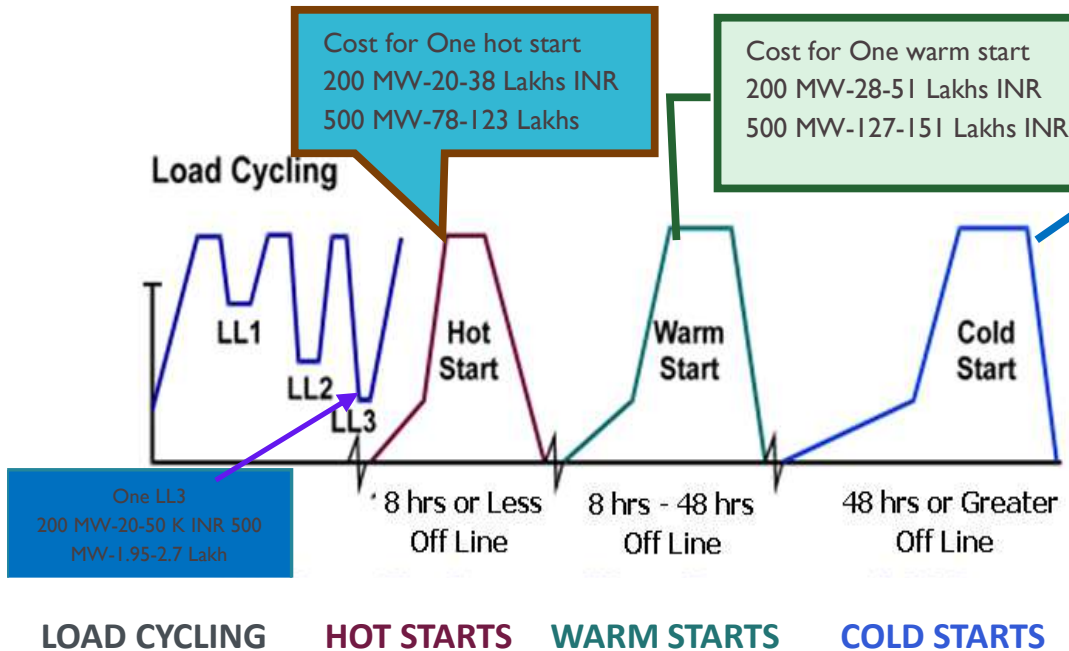

WHY

DO YOU NEED TO PREPARE FOR REDUCING THE LEVEL OF MINIMUM LOAD?

UNIT SIZE	200-250 MW	500 MW
Load Following Cost (US\$)	260-650	2500-3500
Hot Start Cost (US\$)	26k-50k	100k-159k
Warm Start Cost (US\$)	36k-66k	165k-200k
Cold Start Cost (US\$)	54k-118k	225k-340k

RAMPING COSTS



STANDARD CURVE

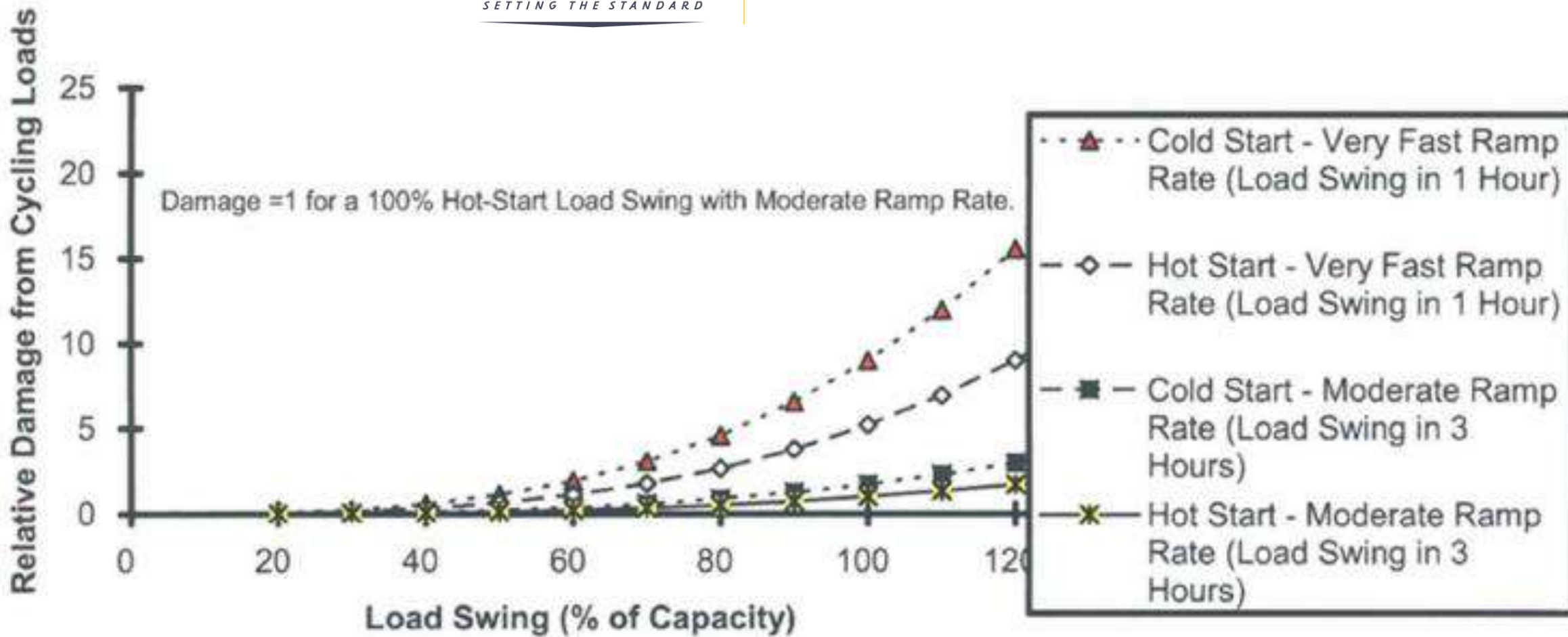

EFFICIENCY ISSUES

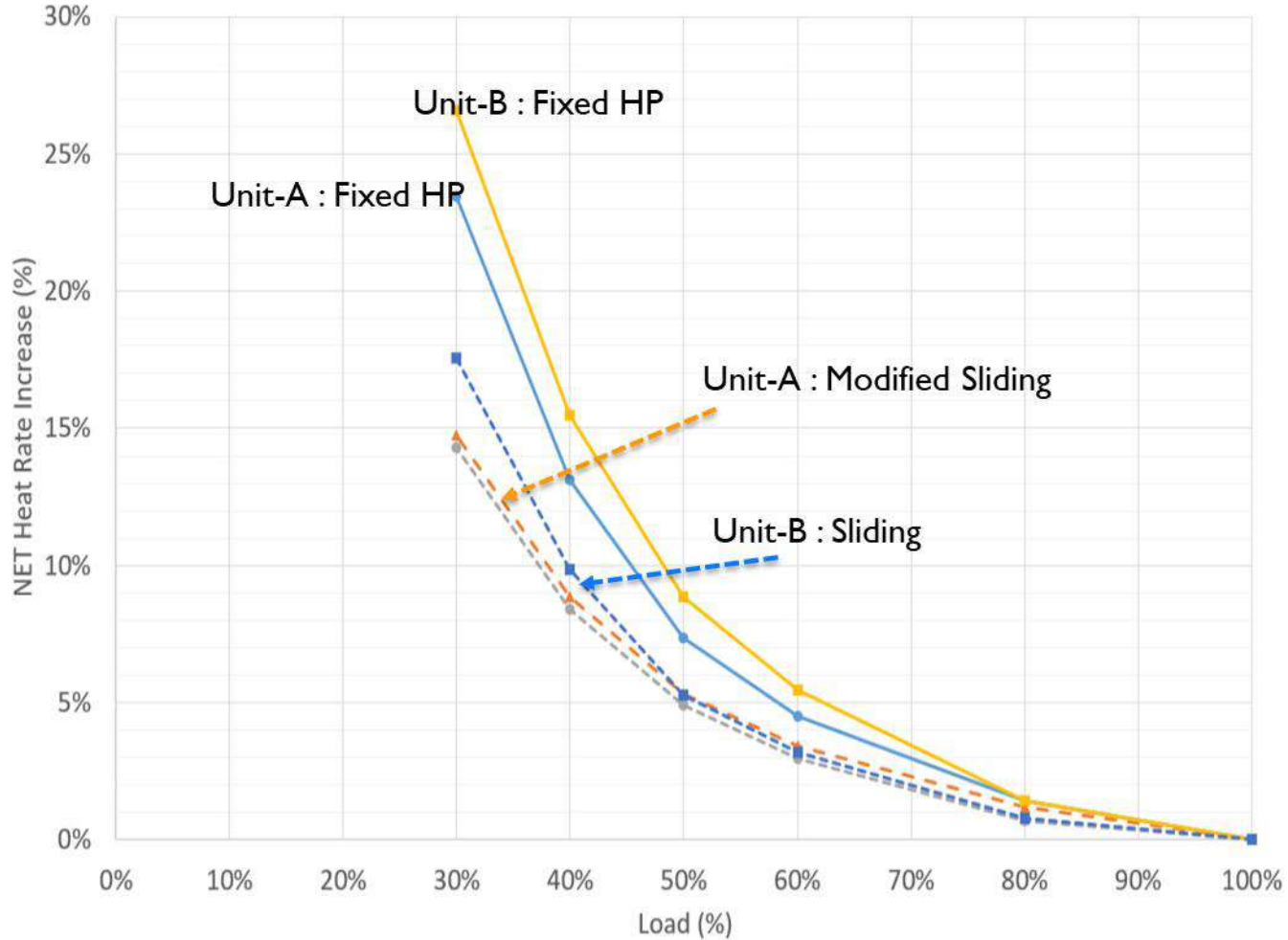

- Burner Performance
- Combustion Issues
- Fuel Issues
- Furnace Heat Balance
- Waterwall Cleanliness
- Refractory & Casing Issues
- Expansion Joint & Duct Failures
- Fan Issues
- Burner Damper/Tilt Issues



RELIABILITY CONCERNS

Tube Failures

Outages Caused
by Control
Issues

Casing/
Refractory
Failures

Burner Failures

Chemistry Issues

FAC

Boiler Auxiliary
Failures

HEP Issues

Design Issues

Start-Up,
Shutdown &
Cycling Issues

Fuel Piping
Failures

Other Issues

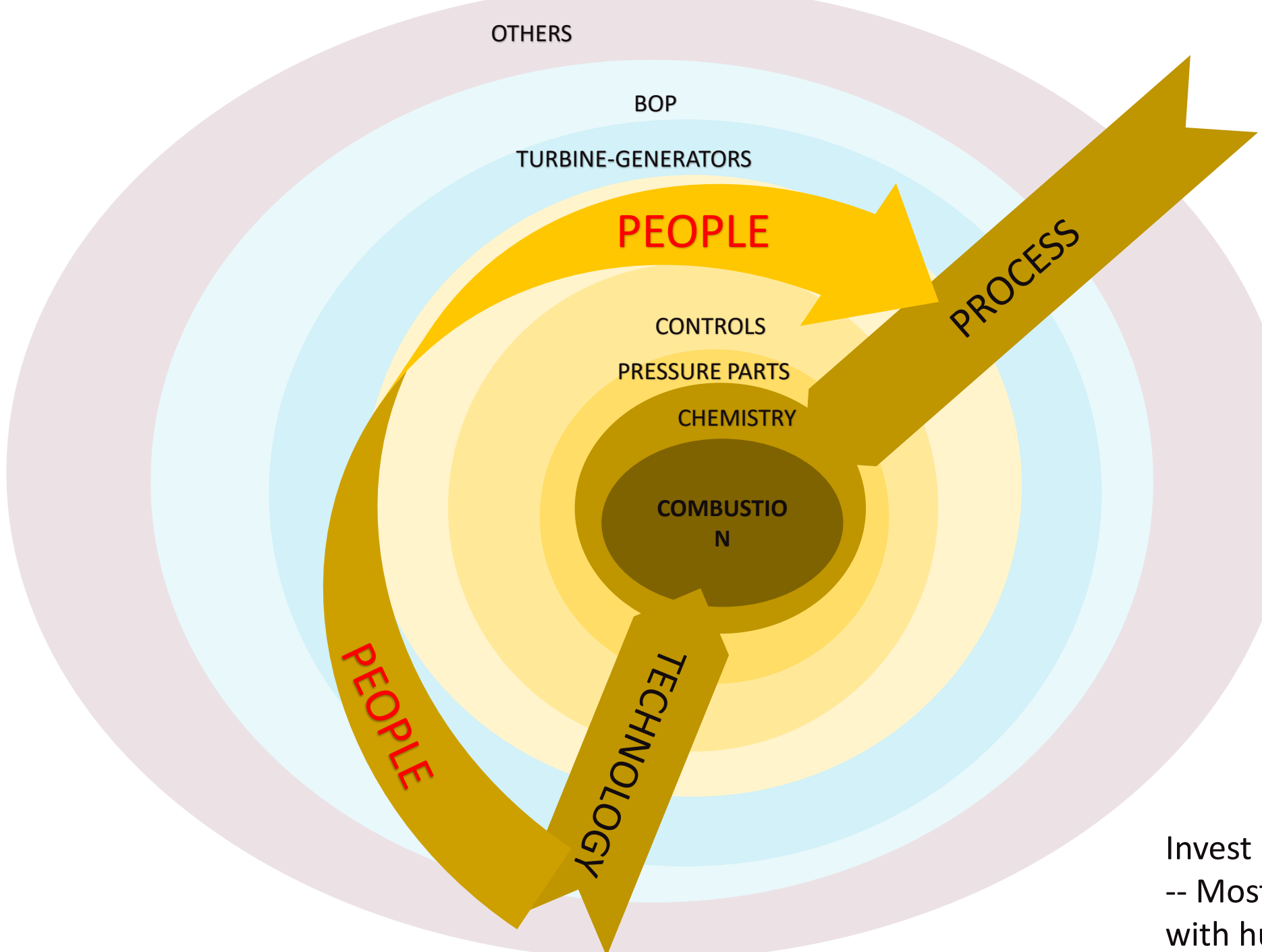

**No magic solution
or one-fit-for all
solution**

Flexible operation
needs a
comprehensive
approach

Invest in capacity building
-- Most cost effective solution
with huge pay back

HARSH REALITIES OF CYCLIC OPERATION

- Flexing with lack of awareness, can be **DISASTROUS**
- Cycling causes **DAMAGE** and when equipment degrades, performance degrades
- Damage not immediate but **ACCUMULATED** and not easy to quantify
- By the time symptoms of damage is visible it may have become **VERY COSTLY** to correct
- Flexible operation is a difficult mode of operation and even the most conservative approach will increase plant **O&M COSTS** along with per MW variable costs
- Plants that can operate flexibly to meet market conditions while minimizing the financial impact of operating in this environment will continue to be dispatched at least for the near future
- Investments in **RETROFITS** can enhance the flexibility to a large extent
- Revisiting the **O&M PROCEDURES, TRAINING & DIGITALIZATION** support can enhance flexibilization
- **COMPREHENSIVE APPROACH NEEDED INVOLVING**
- **PEOPLE, PROCESS & TECHNOLOGY**



OPTIONS VS COSTS

COAL FLEXING IN INDIA

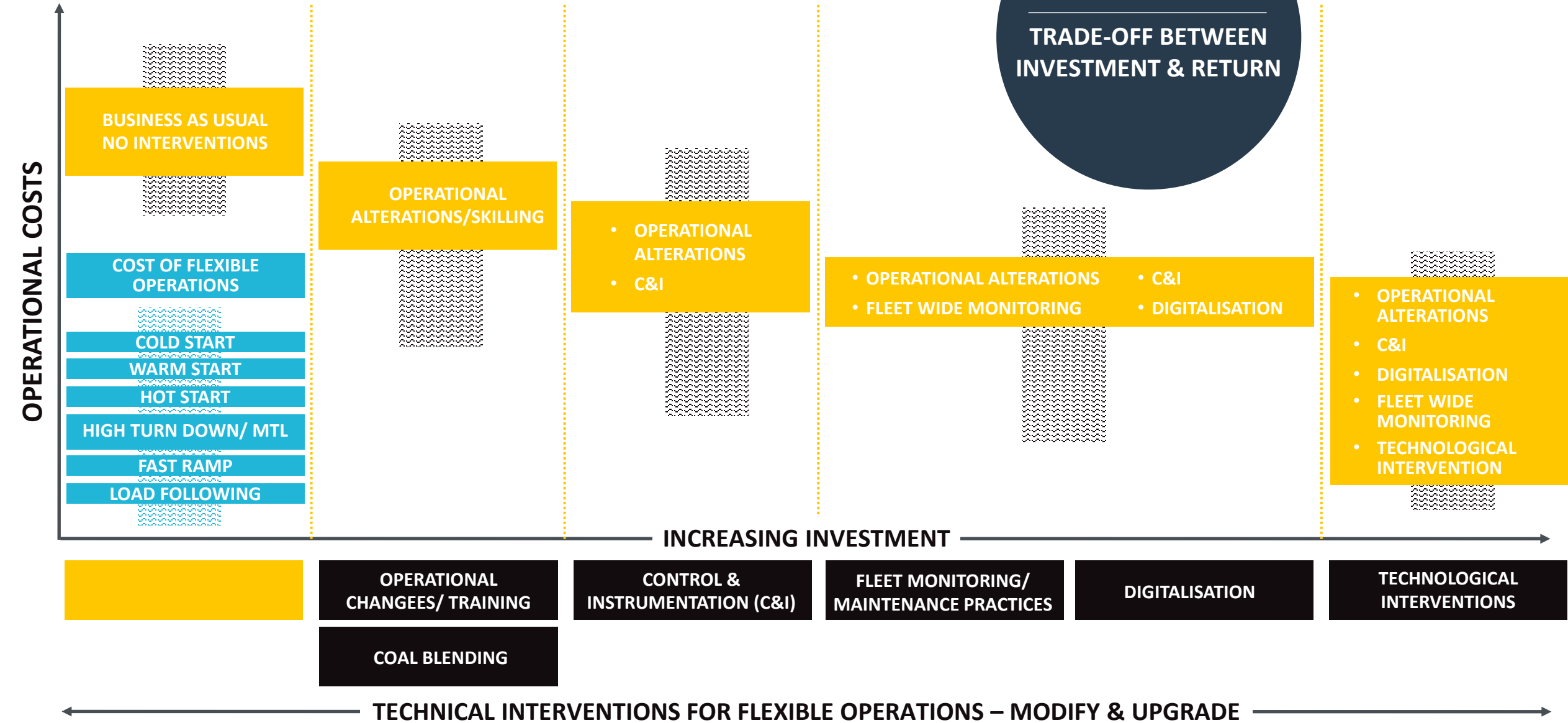

BENCHMARKING METRICS & KPI

Knowing the COMPONENT-WISE CYCLING COSTS is Necessary for deciding Maintenance Schedules

DEFINING from Different Perspectives

- Minimum Load, Ramp Rate, Start-Up Time & Reserves

MEASURING Metrics & Quantifying

- Cost Components – EHS, EFOR, EOH & Reliability

OPERATIONALISATION of Sources, Options & Preparedness for Coal-Based Plants

- Merit Order based on Variable Cost, Heat Rate & Emissions

COMPENSATION/ INCENTIVISATION within Regulatory Framework, Market Structure & Mechanisms

- Ancillary Service, DSM, AGC & Real-Time

FLEXING & OPERATING – choosing which units to **FLEX** is based on **TECHNICAL CAPABILITY & MARKET MECHANISMS** and to **OPERATE** is based on the **VALUE** it can provide to the system

- Ramping
- Start-Up Time
- Off-Line Capabilities
- Spinning Reserves Capability
- Primary Reserves Capability
- Minimum Stable Generation
- Automatic Voltage Regulation (MVar)

DEFINING NEW FLEXING PRODUCTS

- Merit Order Dispatch
- Marginal Cost Pricing
- Opportunity Cost Pricing
- Price Discovery

KPI

- Simple to Understand & Calculate
- Include Cost-Benefit Approach
- Prioritise
- Include Techno-Economics/ Market Based
- Generalisability/ Easy to compare across Units

One KPI could be **Economic Weighted Availability Factor** – availability has different value when there is demand & high market price which can be useful in planning for maintenance to enable the unit to deliver flexibility services when required.

CATEGORISATION OF UNITS FOR DIFFERENT MODES OF OPERATION

CATEGORY

METRICS

Base Load 140GW/299Units	ECR<< State M.O. GCV < 2800,VM<15% Supercr. (except 14 Units)
Flexible-Low Load	ECR=> State M.O.(>Rs.2.5/KWH) GCV >2800,VM > 15%
Flex with Efficiency Retrofit	Units>25 Years Unit size-200 and above HR> 2500
Flexible Daily Start	ECR>> State M.O. (unlikely to get schedule in 2022) HR>2500, GCV>3400
Retire/ Replace	>25Years HR>2600 Unit sizes<200 MW

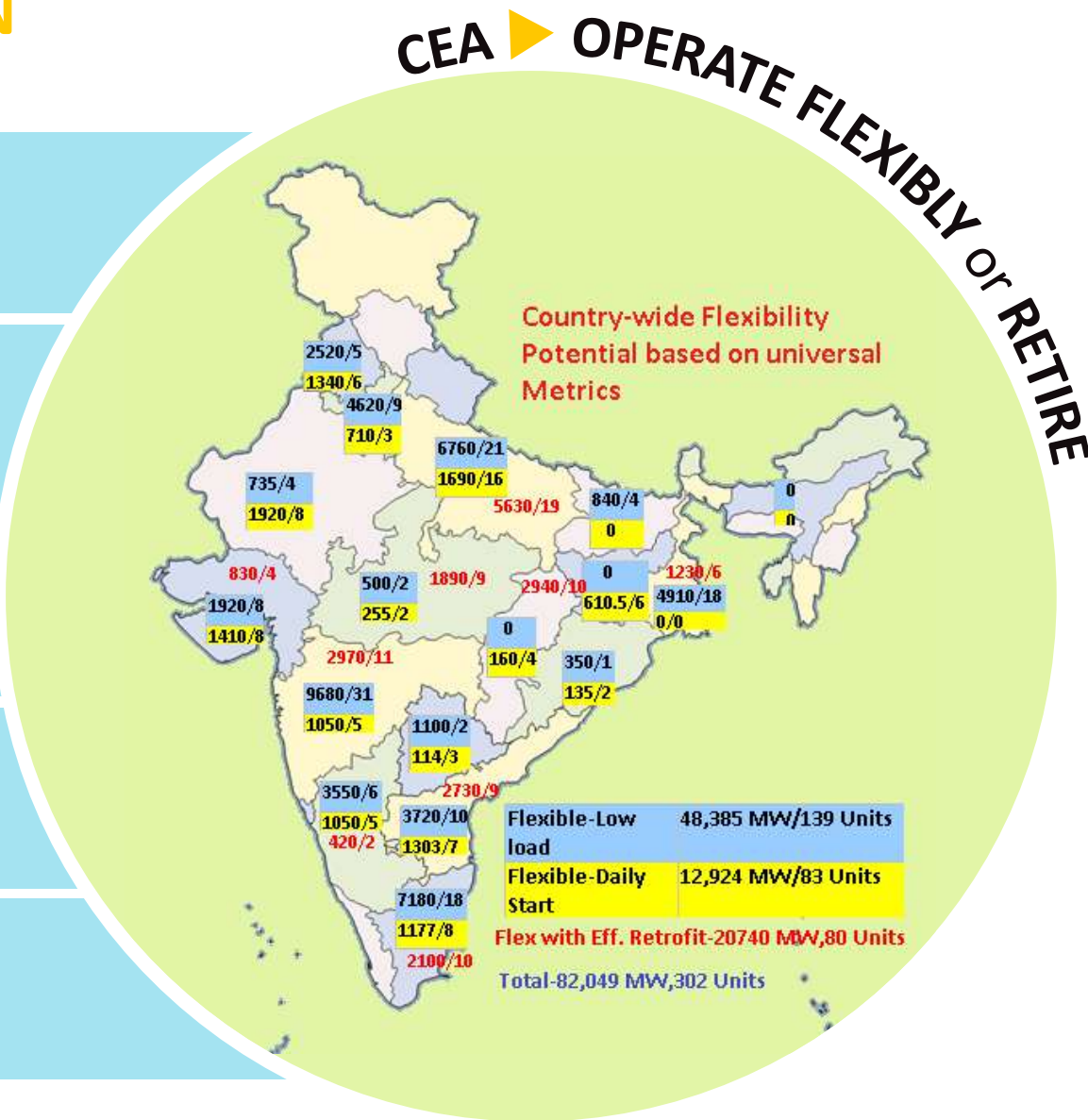

CEA'S ORDER MANDATES UNITS (TOTTALLING 82 GW) TO OPERATE FLEXIBLY OR RETIRE



CASE STUDIES
INCLUDING PILOT TESTS & INTERVENTIONS

CASE STUDIES

EXAMPLES

GLOBAL

- **NREL** – Cost-Benefit Analysis of Flexibility Retrofits for Coal and Gas-Fueled Power Plants
- **NREL** – Power Plant Cycling Costs
- **NREL** – Western Wind and Solar Integration Study
- **PMJ** – Renewable Integration Study
- **Electricity Supply Board of Ireland** – Cost of Cycling for Irish Electric Supply Board
- **Public Power Corporation of Greece** – Assistance on Phase I Cost Forecasting for PPCG
- **Origin Energy, Eraring Station Flexibility and 2-Shift Operation** – Analysis, Australia
- **EPRI** – Effect of Flexible Operation on Boiler Components: Theory and Practice

INDIA

- **Damage Assessment & Cost of Cycling Studies**
 - NTPC Ramagundam
 - NTPC Jhajjar
 - GSECL Ukai (2 units)
- **Feasibility assessment & pilot tests**
 - NTPC-Dadri, Simhadri, Mauda, Vindhayachal, Farakka
 - DVC Andal, Tata Maithon, Sagardighi
- **Regulatory Support**
 - Inputs for CEA & CERC, through USAID's GTG-RISE programme
- **Implementation**
 - Dadri- Condensate throttling, Mill Auto Scheduler
- **Capacity Building**
 - Knowledge dissemination

CASE STUDIES

SCOPE -FEASIBILITY STUDIES

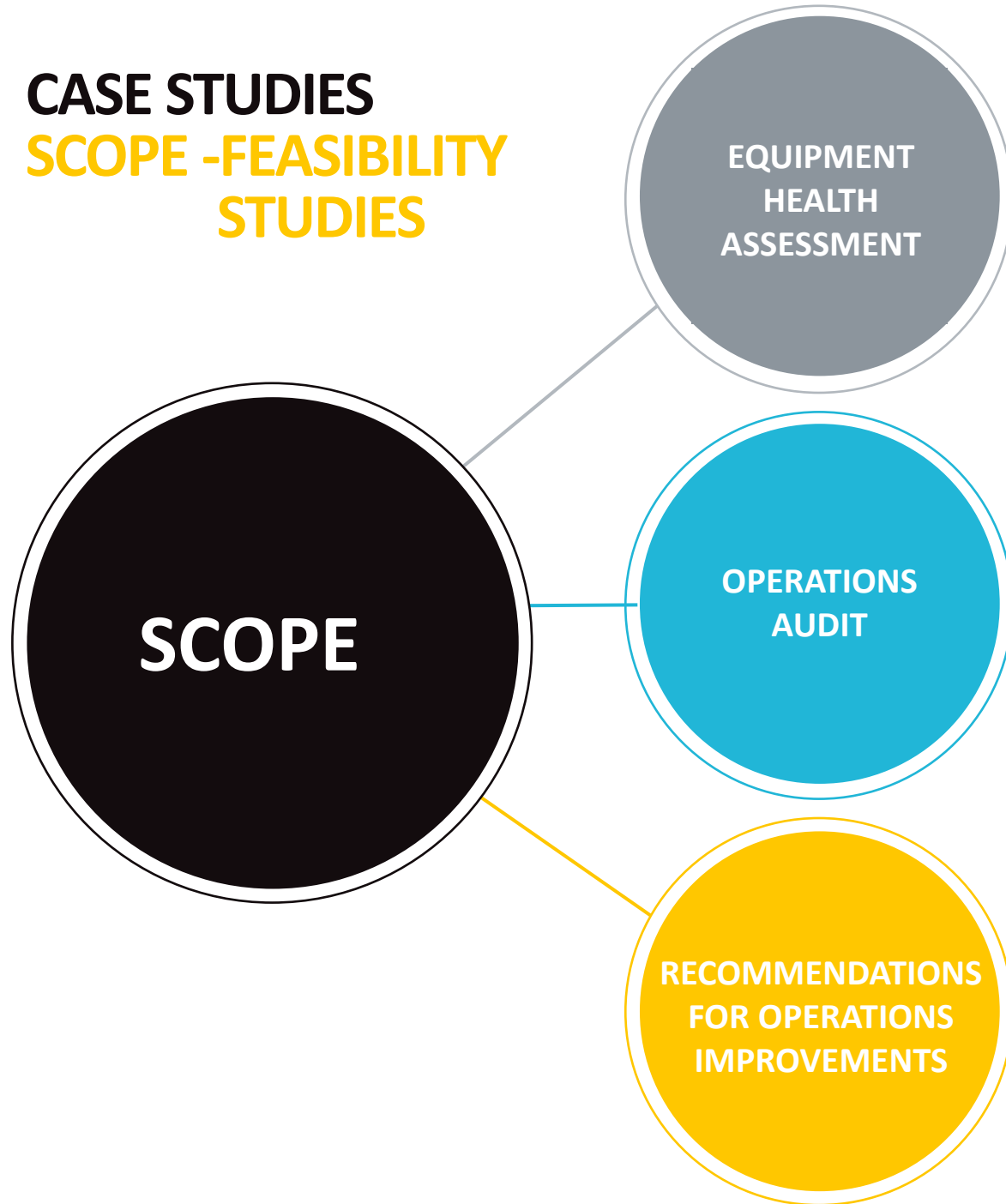

EQUIPMENT HEALTH ASSESSMENT

- Is there any damage?
- What are the damage mechanisms?
- How fast is the damage progressing?
- When will the damage cause failures?
- Are there any low probability but high impact risks?

OPERATIONS AUDIT

- Operating Procedures Review
- Startup & Shutdown
- Protocols (Standing Orders)
- Generation Deficiencies & Incidents Documentation/ Reporting
- Training
- Performance Tests vs Design
- Review of Generation Statistics (FOR, EFOR, Availability, etc.)
- Maintenance & Inspection Schedules, Predictive Maintenance Tools, Spare Usage, SOW
- Digitalisation Maturity
- Usage of Predictive & Condition Assessment Tools
- Design Review & Requirement of Retrofits

RECOMMENDATIONS FOR OPERATIONS IMPROVEMENTS

- Recommendations for Capital Projects To Reduce Cyclic Damage
- Review & Critique Cycling Cost Methods Used By Utility
- Development of Improved Cost Estimates
- Recommendations on use of Improved Cycling Cost Information in System Operations & Planning

Varying Coal Quality posed a major challenge to flexibilization (during test runs)

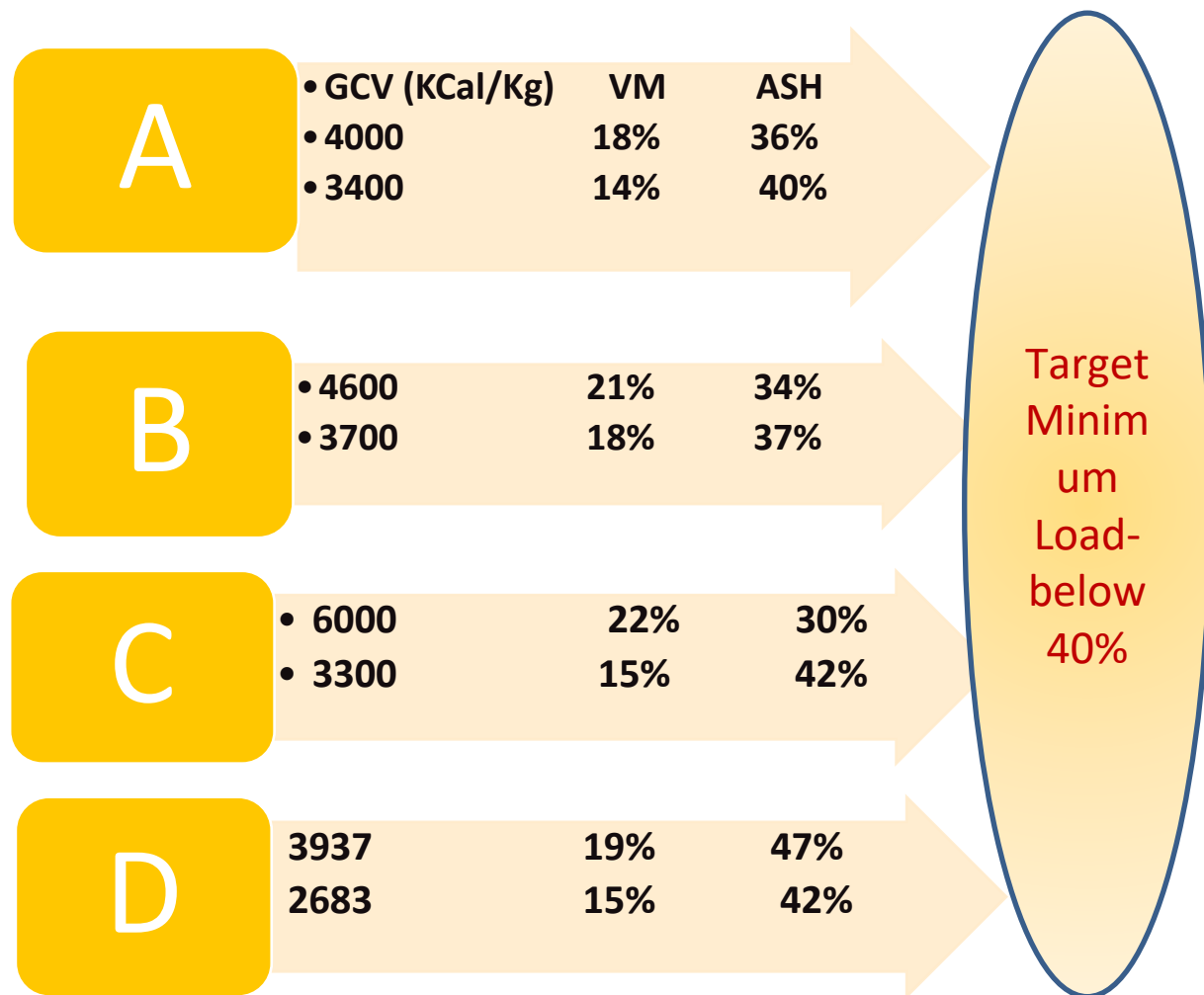

- Burning each grade of coal will require a different operating Regime, which needs to be defined.
- Maintaining combustion stability with Varying coal quality along with varying loads is challenging
- Operating Procedures need to be revisited
- Sufficient, Accurate, Reliable measurements needed

Table No: Samples collected from Coal Stations

Sample	Moist (%)	VM (%)	Ash (%)	FC (%)	HGI	GCV
1	7.2	25.3	36.36	31.14	68.54	3795
2	6.05	25.25	29.92	38.78	59.22	4058
3	8.24	18.34	45.5	27.92	65.2	2869
4	11.45	26.06	38.92	23.57	62.5	3264
5	4.86	31.82	30.02	33.3	58.62	4623
6	6.99	27.79	35.21	30.01	76.09	3871
7	7.41	29.96	32.49	30.14	61.23	4821
8	13.28	20.54	34.46	31.72	48.69	4014
9	9.81	23.45	38.38	28.36	65.93	4268
10	12.96	22.74	46.51	17.79	57.49	2636
11	4.04	28.97	24.26	42.73	60.37	5003
12	6.08	24.01	43.85	26.06	76.65	3692
13	6.58	27.01	38.6	27.81	70.32	3962
14	2.66	22.75	53.22	21.37	57.28	3645
15	7.39	31.05	32.28	29.28	52.33	4538
16	13.6	18.71	46.97	20.72	59.22	2683
17	8.91	20.89	44.67	25.53	63.57	3066
18	4.79	22.11	41.77	31.33	62	3937

Challenges in preparing Units for reducing their level of minimum load ?

PILOT TESTS FOR MINIMUM LOAD & RAMP RATES

To prepare **INDIA'S COAL POWER PLANTS PILOT STUDIES**, test runs were conducted under the directions of MOP and supported by USAID, IGEF, and Jcoal. Important stakeholders included: OEMs (*GE, Siemens, BHEL*), Intertek, VGB , Engie Lab, NTPC, GSECL, KPCL, DVC, Tata Power, WBPDCCL & UPPDCCL.

PILOT LOCATIONS



- **NTPC Jhajjar Power Plant (500 MW)**
Jhajjar District, Haryana, India at 28.4892° N & 76.3557° E
- **NTPC Ramagundam Power Plant (200MW)**
Peddapalli District, Telangana, India at 18.7589° N & 79.4555° E
- **NTPC Dadri (200 & 500MW)**
UP. India at 28.5985° N & 77.6087° E
- **NTPC Simhadra (500 MW)**
Visakhapatnam, Andhra Pradesh, India at 17.5961° N & 83.0875° E
- **GSECL Ukai TPP (200 & 500 MW)**
Vagda, Gujarat at 21.2121 ° N & 73.5606° E
- **Anpara A (500MW)**
Sonbhadra District, Uttar Pradesh, India at 24.2049° N & 82.7832° E
- **Bellary (500MW)**
Karnataka, India at 15° 11' 31.5" N & 76° 43' 03.8" E
- **Tata Maithon (500MW)**
Jharkhand, India at 23° 49' 13" N & 86° 45' 36" E
- **DVC, Andal (500MW)**
WB at 23° 34' 55.61" N & 87° 11' 8.62" E



TEST RUNS

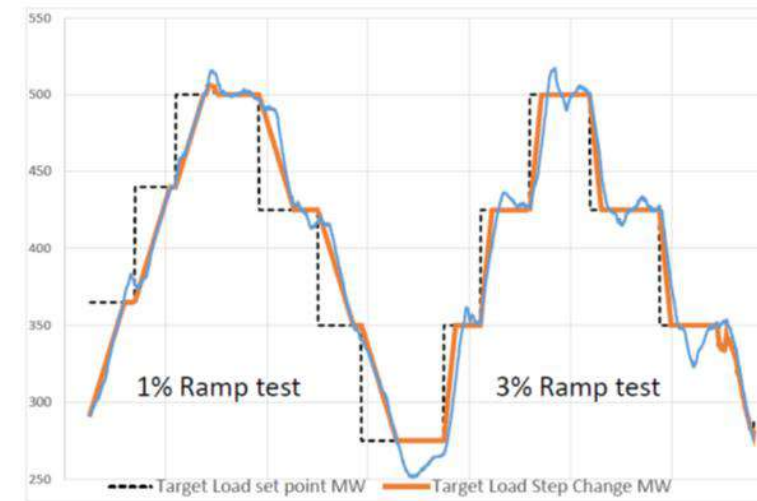

LOW LOAD

- From 500MW to 198MW & BACK with hold points
- 500-360 MW- 5mills
- 360MW-300MW- 4mills
- 300MW-275MW-4mills
- 275-198MW-3 mills (C,D,E)

TURNDOWN OF MILLS

- Loading of mills were reduced till 50% load
- If any mill was required to be loaded below 50%, it was with drawn and other mills loaded

REVIEW OF SLIDING PRESSURE CURVE & PA FLOW CURVE

UNIT ASSESSMENT WITH HP HEATERS BYPASS

RAMPING

- Ramp up/down of 1%, & 3% were checked at different load range
- CMC on except during ramp up @3% from 360-500MW when CMC response was very fast (CMC made off)
- There was a difference in CMC response and actual ramp achieved at lower loads (for 3% ramp)
- Unacceptable deviation in parameter (SH Temp, RH, excessive SH spray)
- Due to thermal shock, falling of big sized clinker which dislocated SC chain
- Sliding pressure needed to be modified
- BFP R/C valve (full open/close) posed problems in drum level control

CONCLUSION

- Upgrade of C&I system needed
- Changes in operational procedures (eg- Soot blowing, Burner tilt operation, air flow, mills selection & turndown)

TEST RUNS

COMMON ISSUES

- In all the test runs conducted, it was observed that **CONTROL LOOPS** were not tuned for low loads
- Burner tilts were on **MANUAL** – key variable having significant influence on steam temperature parameter control
- More number of mills than required were kept in service to take care of the exigencies of **MILL TRIPPING**
- **PRIMARY AIR FLOW** maintained higher than anticipated values as mills were operated at full mill air flow irrespective of the mill loading
- **SECONDARY AIR FLOW** is very much less than the desired level resulting in no or low windbox dP at part loads
- **WB PRESSURE** was improved by closing the secondary air dampers of the mills that were not in service & optimising the primary air flow
- **STEAM COIL APH** was not available/not used regularly
- **SLIDING PRESSURE** was in service – needed modification
- The **PARTIAL STEAMING OF ECO** occurred at low load which can be allowed only for a short time
- Increase in **SH TEMPERATURE** during load ramping
- **HIGH SH SPRAY**
- Jerky operation of **FEED WATER FLOW** on opening of the recirculation valves at low load
- The analysis of **DIRTY AIR FLOW** results reveals that there is a good degree of imbalance in coal flow across the pipes at low load



COMBUSTION OPTIMISATION

- Coal fineness
- Balancing of Coal flow across the coal pipes
- Fuel/Air ratio, Combustion air
- Furnace exit gas temperature
- Bottom Ash & Fly Ash Unburnt
- Flue gas temperature and excess air stratification
- Flue gas oxygen /Excess air level
- Coal mill inlet/outlet temperature
- Primary Air header pressure
- Mill outlet temperature
- Pulverized coal flow velocity /Temperature of coal
- Windbox pressure
- Burner Tilt
- Flame scanners
- Coal fineness
- Selection of burner

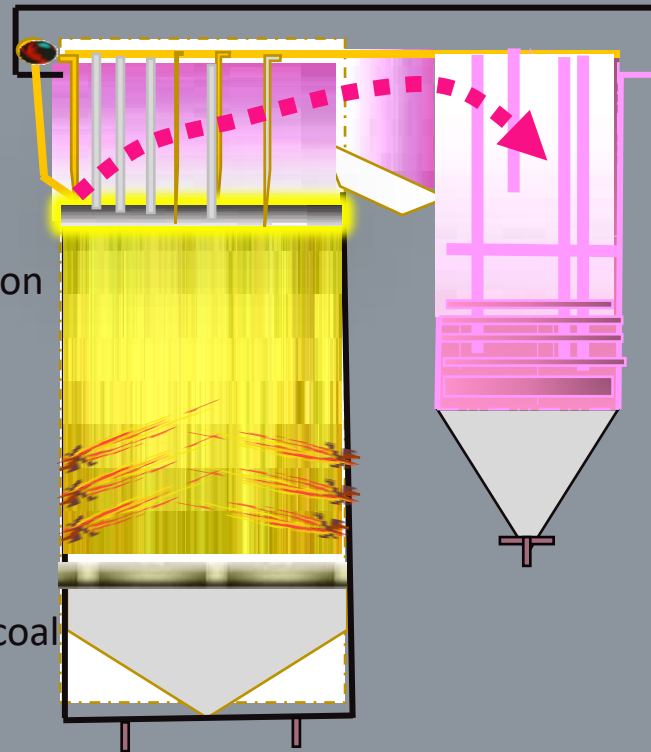

Flame scanners modifications
Burner modification

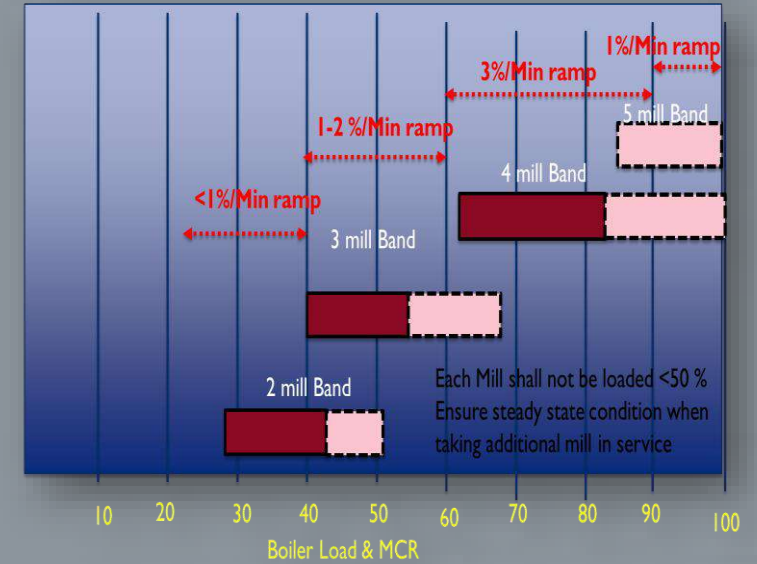

Fuel Firing System Optimization Package

for low load oprn:

- Air/Fuel ratio
- Coal pipes dynamic balancing
- Auto mill scheduler /start/stop
- Coal analyser

Auto Coal Sampler

DYNAMIC COAL FLOW MONITORING AND MANIPULATION SYSTEM

Trending and manipulation Based on Real time measurements

- Coal Mass Flow in each pipe
- Coal Roping Area identification
- Coal Temperature in each pipe
- Coal Velocity in each pipe
- Coal Flow Balancing
- DP across Variable Orifice
- Automatic Coal Pipe Balancing by Variable Orifice (Future proposal)

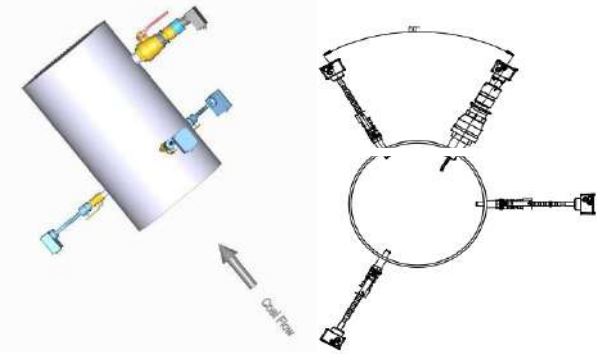

- 3 Mass Flow sensors (microwave based) placed at 120° apart
 - Measures mass flow & indicates coal roping.
- Velocity sensors (Electrostatic based) placed 500mm above the mass flow sensors.
 - Measures coal particle velocity and temperature.
- Monitoring software integrated with system



Unbalanced flow- Unequal fuel/air distribution across coal pipes



Two burner nozzles of the same mill



Erosion due to Coal Roping



DYNAMIC COAL FLOW BALANCING



Before Balancing

	Mass Flow (TPH)	Percentage Mass Flow	Theoretical Equal (TPH)	Percentage Deviation
Total(Mill)	47.2	100%		
Corner-1	11.44	24.24%	11.80	-3.05%
Corner-2	8.96	18.98%	11.80	-24.07%
Corner-3	17.44	36.95%	11.80	47.80%
Corner-4	9.35	19.81%	11.80	-20.76%

After Balancing

	Mass Flow (TPH)	Percentage Mass Flow	Theoretical Equal (TPH)	Percentage Deviation
Total(Mill)	47.16	100%		
Corner-1	11.3	23.96%	11.79	-4.16%
Corner-2	11.55	24.49%	11.79	-2.04%
Corner-3	12.48	26.46%	11.79	5.85%
Corner-4	11.82	25.06%	11.79	0.25%

Coal Pipe	Initial Setting - BHEL RECOMMENDED ORIFICE OPENING	Final Setting - ORIFICE OPENING TO ACHIEVE BALANCED FLOW
D1	100%	98%
D2	74.5%	85%
D3	70%	51%
D4	78%	76%

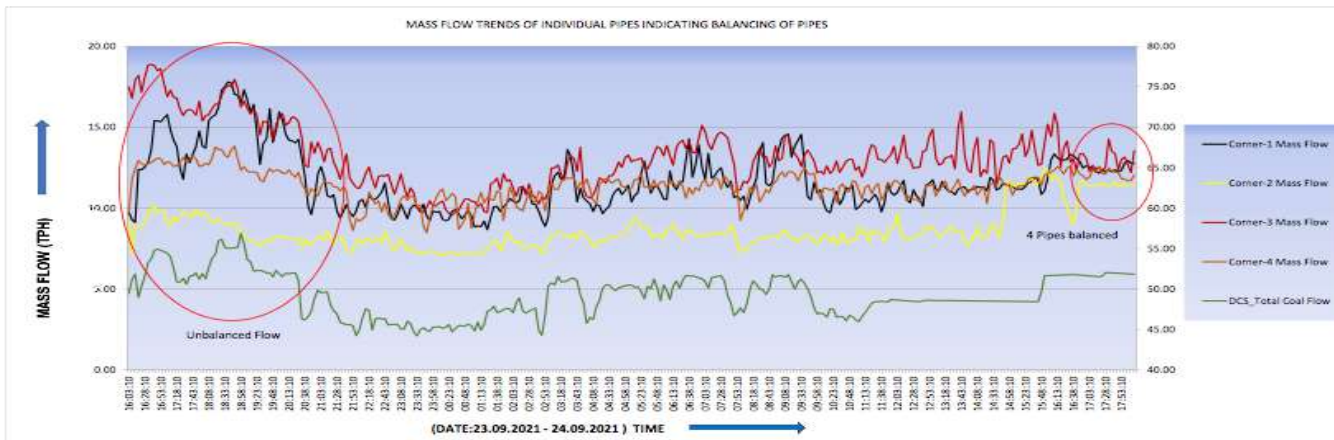

IMPLEMENTATION OF FLEXIBILIZATION RETROFITS

- Condensate throttling at NTPC, Dadri
- Mill Auto Scheduler – Auto-Start of Mills & Fans
- BFP R/C Valve – Replacement with control valve
- Online Coal Analyzer
- Boiler Fatigue Monitoring System

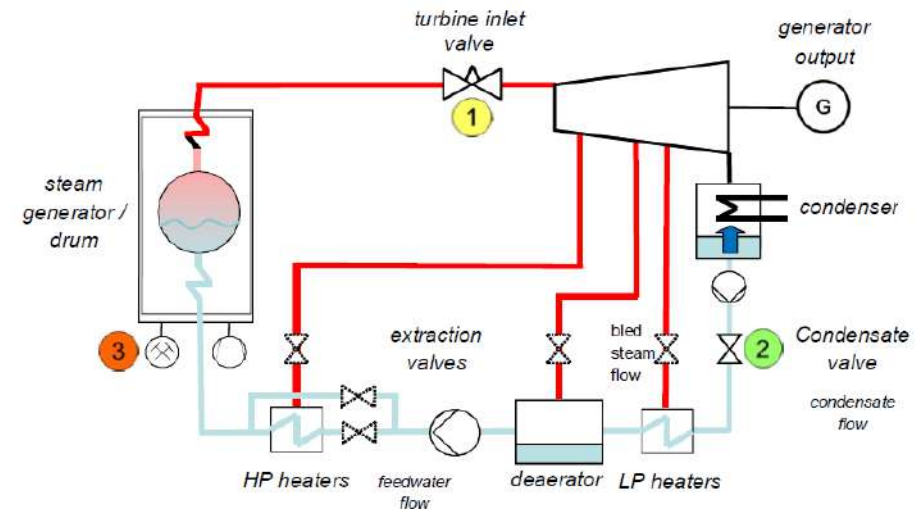
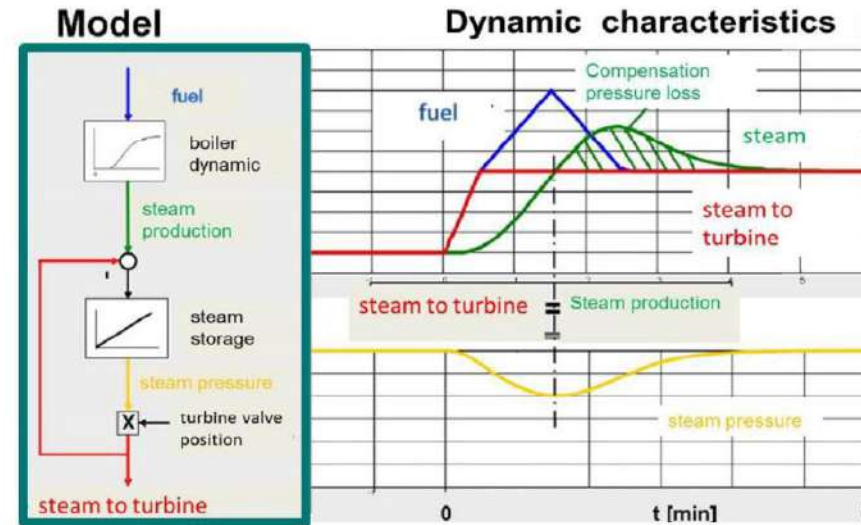

FLEXIBLE OPERATION OF FLEET ROADMAP

AWARENESS | PREDICTABILITY | RISK MANAGEMENT | OPTIMISATION

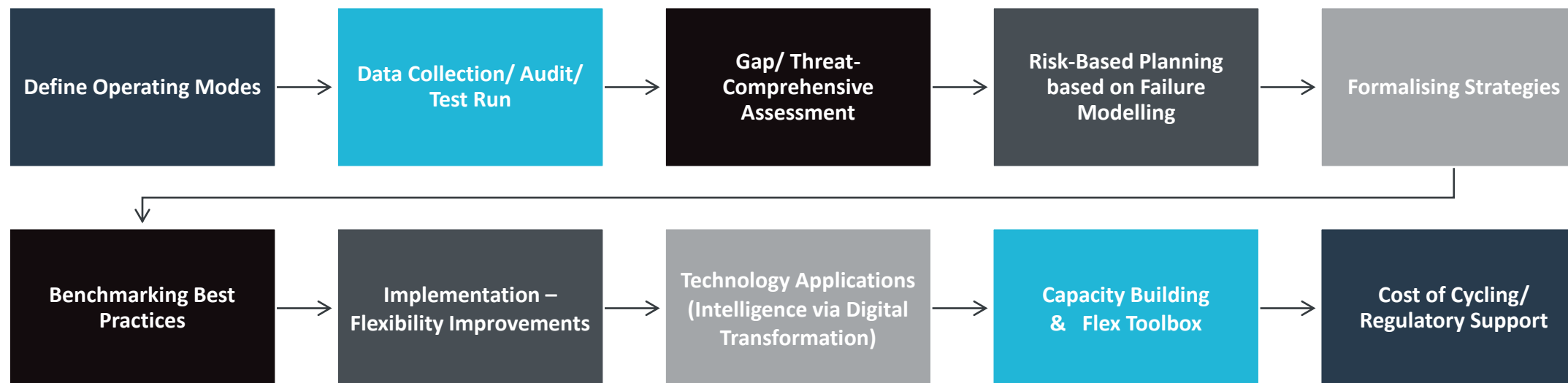

DAMAGES DUE TO FLEXIBLE OPERATION



UNDERSTANDING THE DAMAGES
DUE TO **FLEXIBLE OPERATION**
LEADS TO COSTS & SAFETY IMPLICATIONS



COMBUSTION ISSUES DURING LOW LOADS

- Fuel Quality issues
- Mills Performance
- Burner Performance
- Furnace Heat Balance
- Ensuring Waterwall Cleanliness
- Refractory & Casing Issues
- PA Fan Issues
- Burner Damper/ Tilt Issues
- Other

EXAMPLES OF TYPICAL DAMAGE MECHANISMS

CORROSION

- Acid phosphate corrosion
- Under deposit corrosion
- Caustic gouging
- High temperature corrosion
- Below dew point corrosion
- Out of service corrosion
- FAC
- DNB

OVERHEATING

- Short Term
- Long Term

CRACKING

- Stress Corrosion Cracking
- Thermal Fatigue
- Corrosion Fatigue
- Cyclic fatigue
- Fatigue
- Creep
- Creep Fatigue

PITTING

- Corrodants
- Oxygen
- Hydrogen Damage

EROSION

- Ash
- Saturated Steam
- High Pressure Water
- Loose Connections
- Mechanical Rubbing
- Gases
- Contamination
- Fouling
- Thermal Quenching

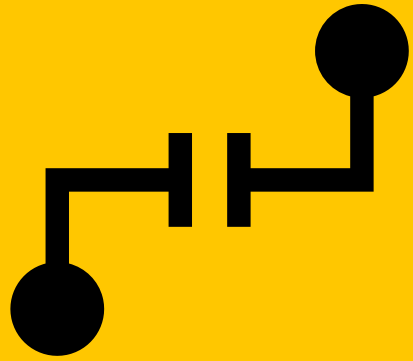

CRACKING OF THICK WALL COMPONENTS



- **RAPID TEMPERATURE TRANSIENTS**
during Starts/ Shutdown &
Ramping Operation
- **TYPICALLY SHUTDOWN OPERATION IS
CRITICAL**
- When cold water is fed during Hot Start-Up
– **LEADS TO QUENCHING**

CRACKING OF LIGAMENT BETWEEN STUBS

PIPE CRACKING

FAILURES DUE TO TEMPERATURE TRANSIENTS & ACID DEW POINT CORROSION

TEMPERATURE TRANSIENTS

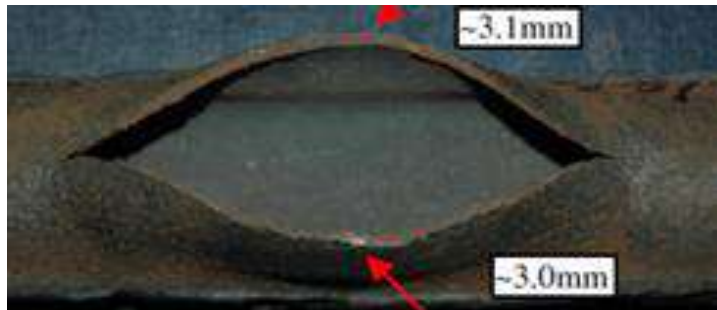

WW FAILURE – 3 HOURS OF START-UP
(SHORT-TERM OVERHEATING)



SH LT OVERHEATING
(SHORT-TERM OVERHEATING)

- Inadequate steam flow
- Drainage is critical (operation in auto)
- Ensure adequate flow in SH

ACID DEW POINT CORROSION

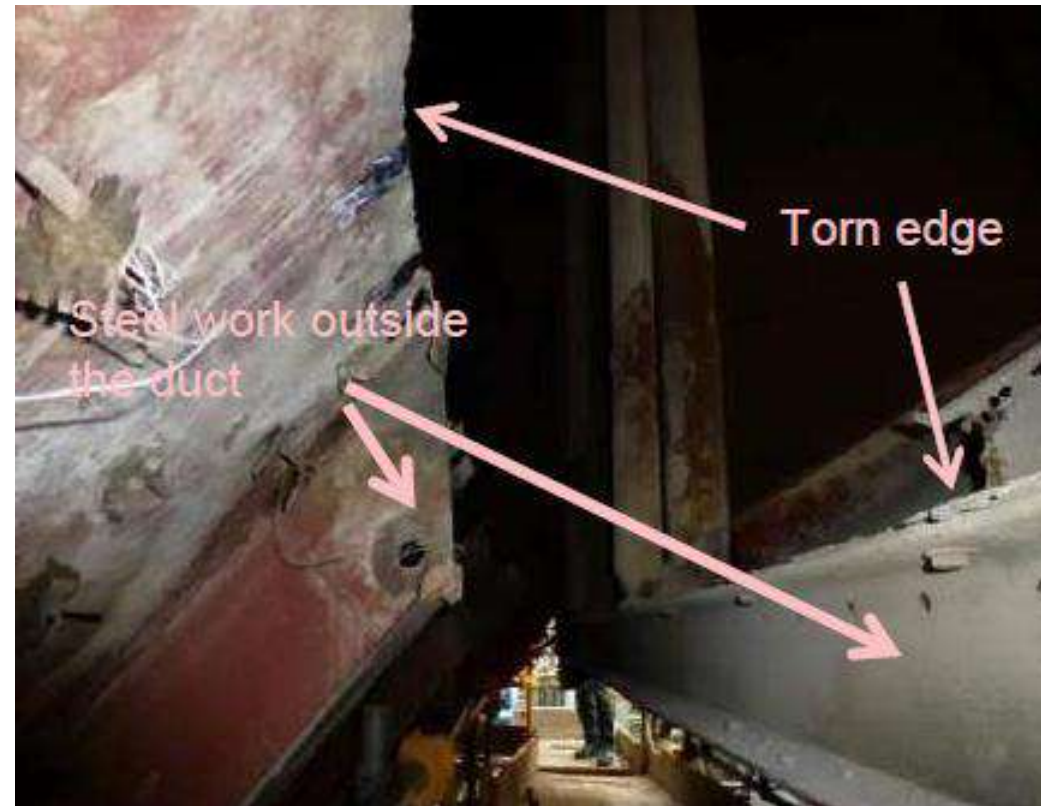

ESP COLLAPSE

Continuous operation with Flue Gas temperature close to acid dew point

DAMAGES TO TURBINE BLADES

EXFOLIATION/ PITTING

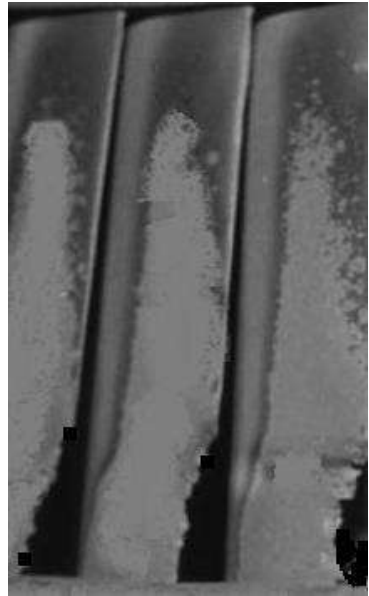

EXFOLIATION



DAMAGE TO SEALS



PITTING



PITTING

OTHER AREAS include:

- Turbine Valves
- Damages due to Uneven Expansion
- Hammering in Pipelines

COMMON REASONS for **DAMAGES** apart from **TEMPERATURE TRANSIENTS** are:

- Excessive Use Of Spray & Water Carry Over
- Chemistry
- O2 Ingress

CHEMISTRY RELATED DAMAGES



TURBINE SIDE STRAINERS DAMAGE

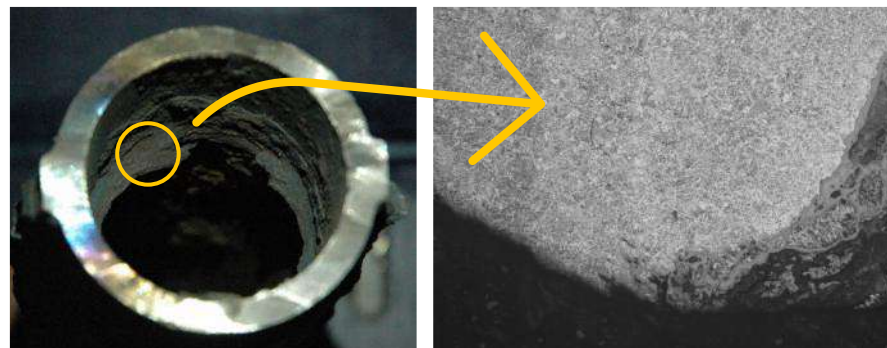

SCALE DEPOSITS



PITTING

PA FAN STALLING



Typically, in stations where there are two PA fans for full load, at low load, **STALLING** is common

Unless operating procedures are modified, there can be **SEVERE DAMAGE**



BOTTOM ASH EXPLOSION DURING LOW LOAD OPERATION

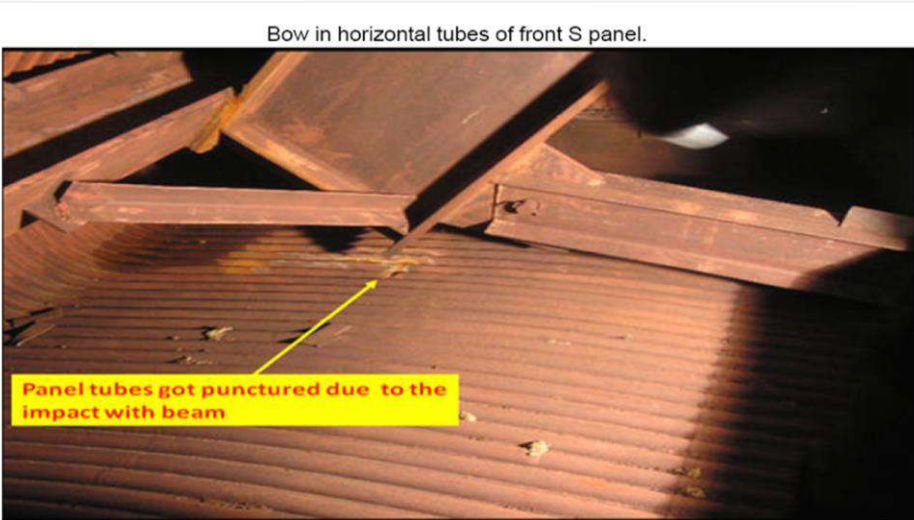
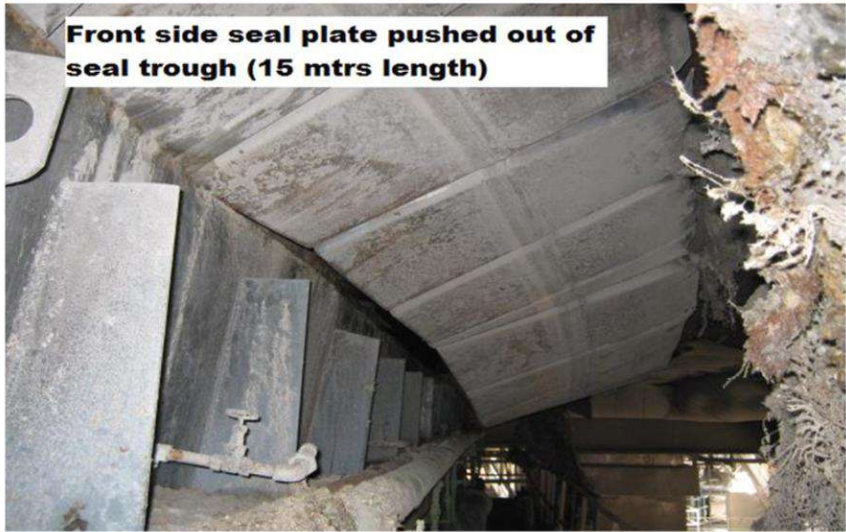

Location of failed tubes

UNDERSTANDING THE DISTRIBUTION OF TOTAL COSTS OF DAMAGE

- **NECESSARY** to tailor the Overhauling & Maintenance Intervals of Units supported by Data
- Analysis of Component-Wise Cost Data is **IMPORTANT**
- Predictive Tools
- Estimated Weekly Damages
- EFOR & Life Management Actions
- Intertek COSTCOM, AWARE, EPRI, GE ...

ANNUAL COST OF CYCLING DISTRIBUTION

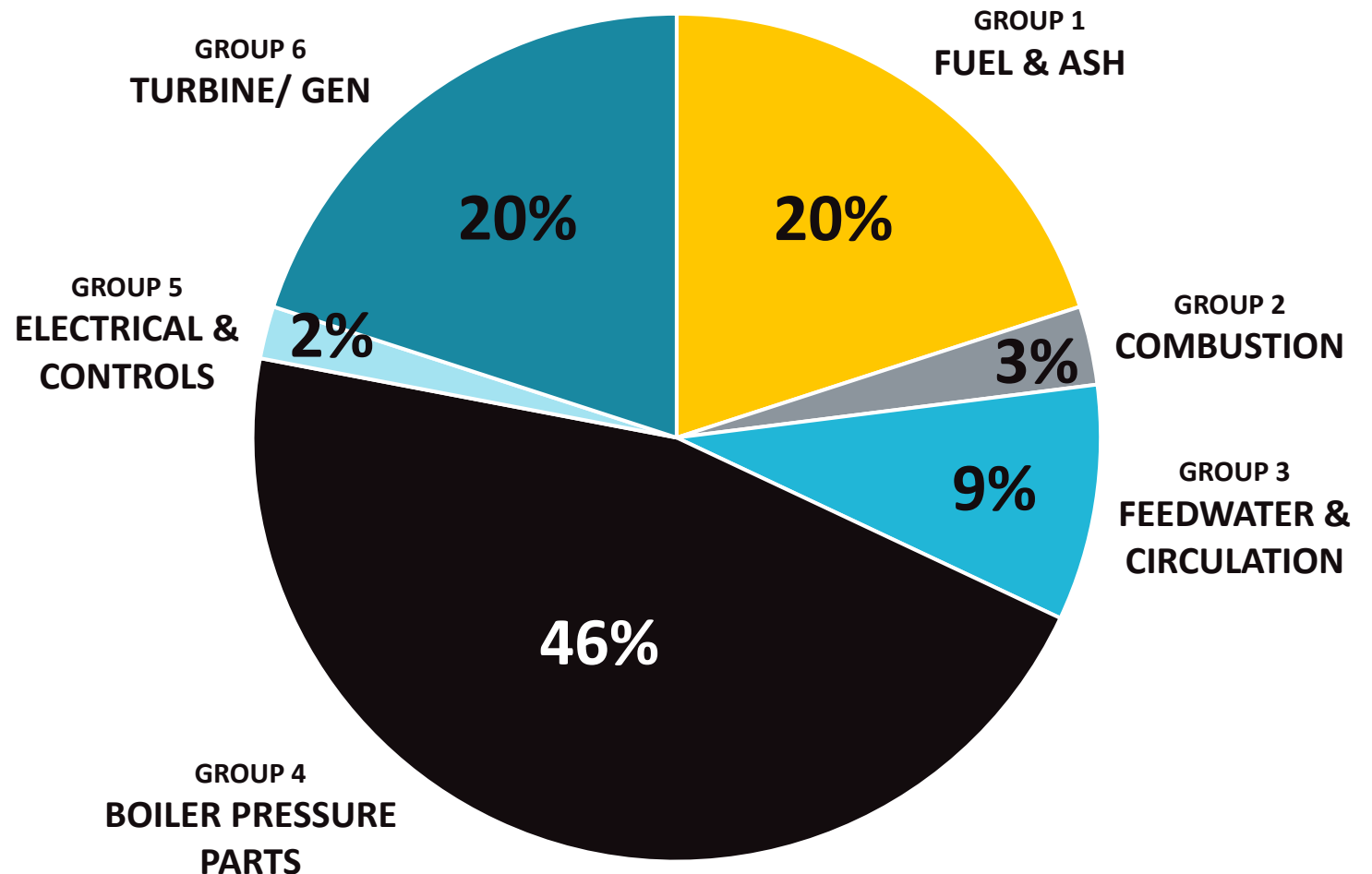

SUMMARY

- Flexible operation does not have a one-fit-for-all solution

- The mode of flexible operation will depend on the market context, fuel costs, plant design, vintage

- Interventions and Investments for flexible operation have to be based on cost-benefit analysis.

The first thing for flexible operation is awareness of the damage mechanisms and the cost & risks associated with each type of flexible operations – with awareness, there can be a huge reduction in the costs of cycling

Flexible operations will need changes in operating procedures, a different approach with respect to inspection strategy and outage intervals/ scope

Tools are available for managing plant integrity, improving reliability and part load efficiency

Preparations for flexible operation needs a comprehensive approach (people, process, and technology)

Thank You for your Attention

Anjan Kumar Sinha
9650992971
Sinha.anjan@gmail.com

REDESIGNING TARIFF STRUCTURE TO REFLECT COST OF FLEXING



REGULATORY INTERVENTIONS FOR ENHANCING FLEXIBILISATION

TYPICAL COSTS OF DELIVERING FLEXIBLE POWER FOR RE-INTEGRATION FROM COAL

COST OF FLEXIBLE OPERATIONS	FACTORS	PARAMETERS
	ENERGY CHARGES	<ul style="list-style-type: none"> Start-Up Cost increases due to increase in <ul style="list-style-type: none"> Heat Rate APC Oil Support
	O&M COST	<ul style="list-style-type: none"> Increased EFOR Accelerated Life Consumption due to <ul style="list-style-type: none"> Start-Ups Load Following
	FIXED COST	<ul style="list-style-type: none"> Accelerated Life Consumption will have impact over unit availability in long-term EROF can impact unit availability in short-term
	ENVIRONMENTAL IMPACT	<ul style="list-style-type: none"> Specific (Kg/MWh) Nox, Sox & CO emissions will be somewhat higher at unit levels while flexing Overall emission would reduce for flexible units due to reduced coal usage Significant adverse impacts are very unlikely due to installation of emission control devices

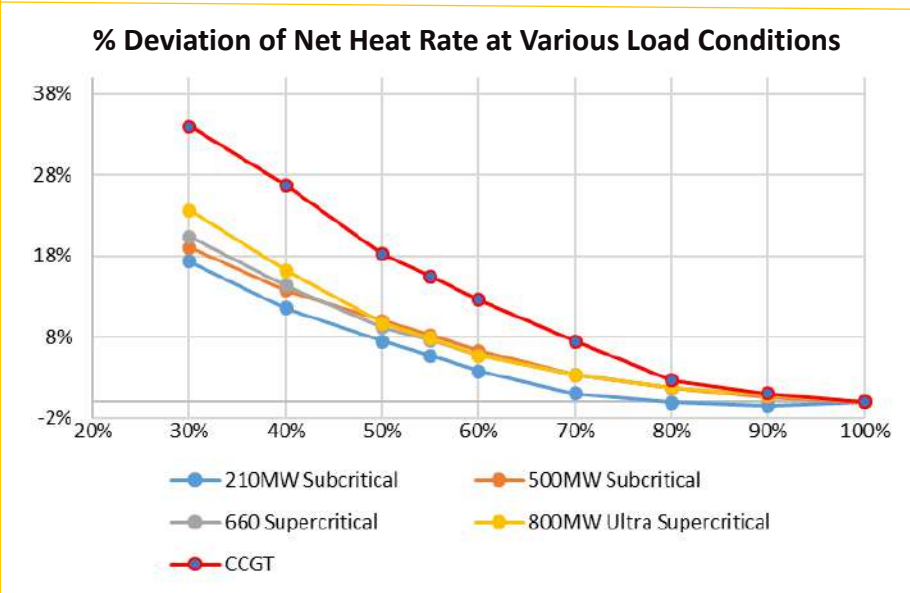
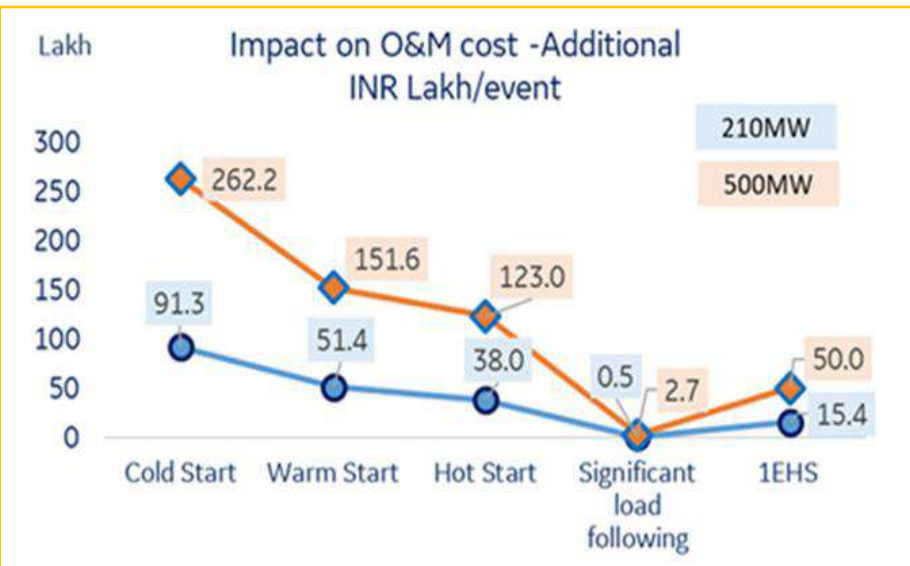

IMPACT ON TARIFF

FC + ECR – 200P/KWH

TYPICAL 200/210 MW UNIT	UNIT LOADING %	DUE TO HR	ADD O&M	START-UP ALL	TOTAL IMPACT (FC+VC)
		ADDL. PAISA/KWH			
		90%	0	0	0
80%	0	0	0	0	
70%	2.1	3.31	0	5.4	
60%	7.5	3.31	0	10.8	
50%	15	3.31	2.5	21.3	
40%	23.2	3.31	2.5	29	
30%	34.6	3.31	2.5	40.5	
WEEKLY START	---	23.2	60.22	14.8	98.2
DAILY START	---	7.5	257.39	35.2	330.1

TYPICAL 500 MW UNIT	UNIT LOADING %	DUE TO HR	ADD O&M	START-UP ALL	TOTAL IMPACT (FC+VC)
		ADDL. PAISA/KWH			
		90%	1.1	0	0
80%	3.4	0	0	3.4	
70%	6.7	7.15	0	13.8	
60%	12.6	7.15	0	19.7	
50%	20	7.15	0	27.2	
40%	27.6	7.15	0	34.8	
30%	38	7.15	0	45.2	
WEEKLY START	---	27.6	69.18	10.7	107.5
DAILY START	---	12.6	307.74	43.5	363.8

COMPENSATION PROPOSED

INDIA

AGAINST HEAT RATE LOSS

AGAINST APC LOSS

S. NO.	UNIT LOADING AS A % OF INSTALLED CAPACITY OF THE UNIT	INCREASE IN SHR AS A % FOR SUPERCRITICAL UNITS	INCREASE IN SHR AS A % FOR SUPERCRITICAL UNITS
1	85 & Above	Nil	Nil
2	80	0.66	0.76
3	75	1.19	1.45
4	70	1.96	2.40
5	65	2.84	3.56
6	60	3.67	4.79
7	55	4.92	6.59
8	50	6.15	8.60
9	45	7.40	10.21
10	40	8.81	12.14

SL. NO.	UNIT LOADING % OF MCR	% DEGRADATION IN AEC ADMISSIBLE
1	85 & above	Nil
2	80	0.10
3	75	0.25
4	70	0.40
5	65	0.55
6	60	0.75
7	55	0.95
8	50	1.20
9	45	1.55
10	40	2.10

Minimum Turndown 55% **MANDATORY &** Below 55% **OPTIONAL** with Provisions for Compensation

OIL COMPENSATION FOR EVERY START

OVER & ABOVE
7TH START/ YEAR

OIL CONSUMPTION PER START-UP (KL)

UNIT SIZE	HOT	WARM	COLD
200/ 210/ 250 MW	20	20	50
500 MW	30	30	90
600 & Above MW	40	60	110

Additional Oil Consumption Proposed for **LOW LOAD OPERATION** because of Loss of Reliability

Up to 0.5ml/ Kwh

COST COMPENSATION EXAMPLES

INDIA

- CERC vide issuance of 4th Amendment to IEGC Regulations 2010, notified the Technical Minimum in respect of a unit(s) for CGS or ISGS as 55% of MCR loading or Installed Capacity of such unit(s). Amended regulations also provide for compensation for the following:
 - Heat Rate Degradation
 - Increased Auxiliary Consumption
 - Increased Oil Consumption
- Coal based plants operating on flexible modes i.e., $P_{min} < 55\%$ and subject to cycling, load following, and two-shifting require additional compensation mechanisms/ allowances for increased CAPEX and OPEX costs
- Regulatory provisions for frequent start-ups & high ramping needs to be evolved
- Ancillary Services need to recognize costs of flexibility (in regulated approaches) or provide a market mechanism which allows for recovery of additional costs



CAISO

- Supply Offer in CAISO would have the following cost components (considered in the SCED co-optimisation of energy and ancillary markets)
- Start-up costs associated with bringing a resource online from being shut down:
 - Broken down into Cold, Intermediate & Hot Start-Up Costs
- Operational Ramp Rate expressed in megawatts per minute (MW/min) as a function of the operating level - must be a staircase function with up to four segments.
- Transition costs associated with moving from one configuration to another for multi-stage suppliers (MSG)
- Minimum load costs associated with operating the resource at the minimum operating level (P_{min}) where a resource cannot drop below without compromising the resource's operation
- Incremental energy costs associated with producing energy above P_{min} at each operating level



CHINA BENEFITTED FROM THE DOWN REGULATION MARKET

CHINA

- Introduced in Northeast China in 2014 encourage investment in flexibility in this area
- Down-regulation became the scarcest of resources in the system Concept D-R market - punish inflexible power plants & reward flexible plants
- A baseline of D-R capability is 50%. Plants operating above baseline when the system has a generation surplus, pay plants operating under the baseline
- The settlement on a 15-minute basis
- The total cost is allocated proportionally to those power plants that operate above the baseline during that time period
- The curtailed electricity has been reduced by about 1/3

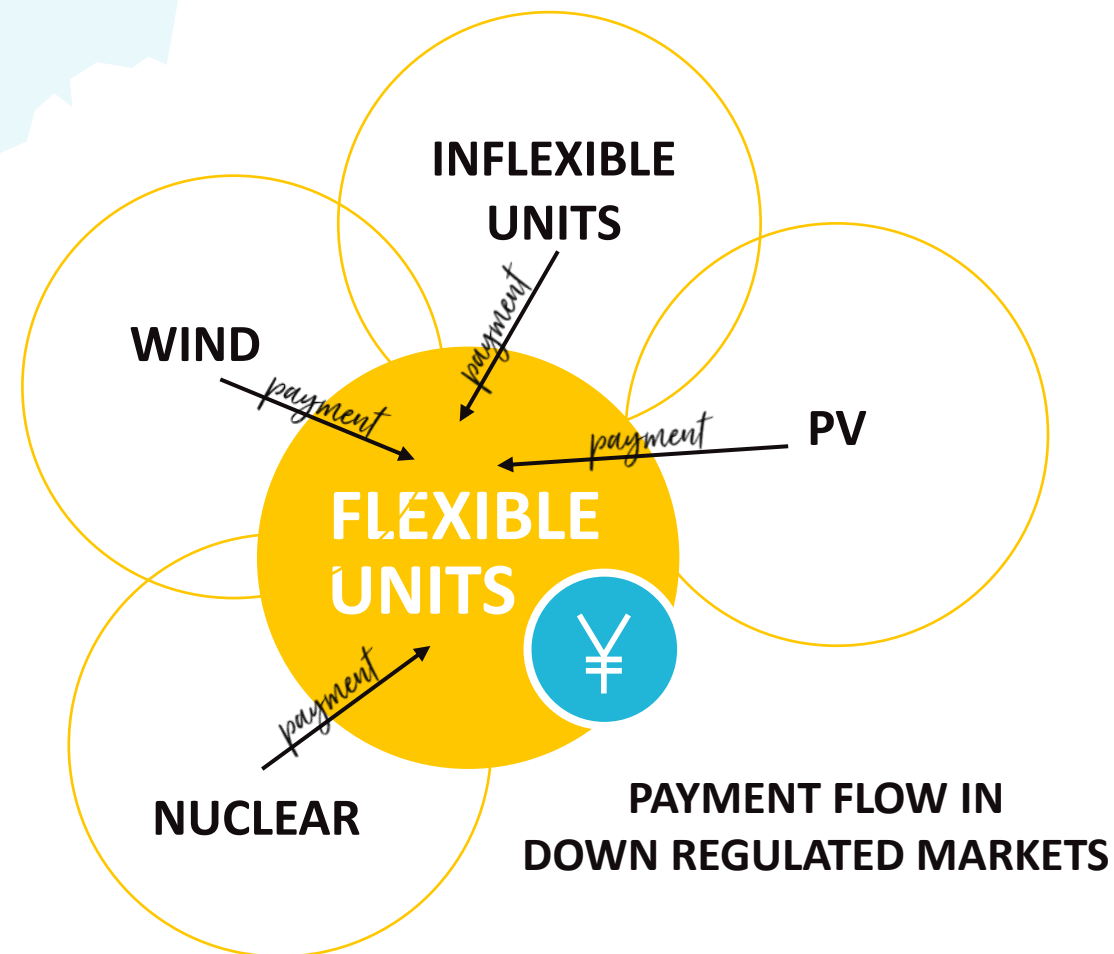

CAPEX FOR PREPARATION UNITS FOR FLEXIBILISATION

INTERVENTION		COST '000" US\$	IMPLEMENTATION TIME (MONTHS)
1	Boiler Model for Temperature Optimization	150	6
2	Mandatory Control Upgrades Minimum Load	250	12
3	Installation of Two Feedwater Recirculation Valves	100	6
4	Mandatory Control Upgrades Ramp Rates	200	9
5	Further Flexibility Enhancement by Controls	500	6
6	Coal Flow Balancing (Five Mills)	500	6
7	Condition Monitoring	300	6
8	Sootblower Optimization	150	6
TOTAL		2150	12

CAPEX would vary across the units depending on:

- Design
- Vintage
- Historical Operation Modes
- Coal Quality
- Degree of Flexibilization required from the unit

It is in the range of INR 20 Crore (US\$ 2.2 Million) to 50 Crore (US\$ 5.5 million)

POLICY & REGULATORY GUIDELINE

INDIA

NATIONAL RENEWABLE ENERGY POLICY

- Focusing on accelerating the use of Clean & Renewable Energy (500 GW by 2030)
- Strengthens “Must-run” Status of RE Provisions of RPO – minimum purchase of 5% (2011) & enhanced to 21 % from 2022
- Proposed Electricity Amendment Act – 2020/21 Provisions for Penalty on **NOT MEETING** the RPO & doubling every successive year on default
- Bundling of RE with Thermal Energy
- Minimum Adequate Capacity Resources
- Ensuring Payment Security Mechanisms (Institutional Mechanisms)



POLICY INTERVENTIONS ON THERMAL PLANTS TO ENABLE THEM TO SUPPORT RE INTEGRATION

- Part Load Compensation for ISGS Units
- Incentivisation for Increased Ramp Rates
- Market Intervention (AGC, RTM, Ancillary Service)
- CEA’s Guideline for Flexibilization of Thermal Plants
- Technical Minimum load @55 % & Ramp Rate of 3% (Sub-critical)/ 5% Super-critical Mandatory
- Plants to achieve capability of 40% min load within 3 years after Interventions/ Retrofits

CASE STUDIES INCLUDING PILOT TESTS





MARKET DRIVERS OF FLEXIBILIZATION OF COAL UNITS

- Renewables Transition in India
- Falling renewable costs, increasing market penetration & intermittency issues
- Increasing Requirements of Ancillary Services, DSM, AGC
- Fuel economics-non-pit head stations will have Costlier Fuel
- Tightening Environmental Legislation
- Inadequacy of Other Balancing Resources
- Transition to Electricity Market Mechanisms

IMPACT OF MARKET DRIVERS ON POWER PLANT

- Shift from Base-load to Flexible Mode of Operation
- Rapid Increase in Unit Starts- Even in New Plants
- Increased need for Load Following
- Reduction in Minimum Load
- Need to Operate Flexibly even with Wider Grades of Coal
- Off-Design Operation and Fuels including Co-Firing (Recent Policy Mandate)
- Need for Refurbishment, Upgrades and Life Extension – Capital Costs
- Plant Lay-up & Standby Requirements
- Uncertain Environment for Investments
- Some Assets become Unviable unless they adapt for survival
- Increased Operational Costs

